



User's Manual

**Industrial Renewable Power
5-Port Gigabit Managed
Switch/Router with 4-Port
802.3at PoE+**

▶ BSP-360



Trademarks

Copyright © PLANET Technology Corp. 2022.

Contents are subject to revision without prior notice.

PLANET is a registered trademark of PLANET Technology Corp. All other trademarks belong to their respective owners.

Disclaimer

PLANET Technology does not warrant that the hardware will work properly in all environments and applications, and makes no warranty and representation, either implied or expressed, with respect to the quality, performance, merchantability, or fitness for a particular purpose. PLANET has made every effort to ensure that this User's Manual is accurate; PLANET disclaims liability for any inaccuracies or omissions that may have occurred.

Information in this User's Manual is subject to change without notice and does not represent a commitment on the part of PLANET. PLANET assumes no responsibility for any inaccuracies that may be contained in this User's Manual. PLANET makes no commitment to update or keep current the information in this User's Manual, and reserves the right to make improvements to this User's Manual and/or to the products described in this User's Manual, at any time without notice.

If you find information in this manual that is incorrect, misleading, or incomplete, we would appreciate your comments and suggestions.

FCC Warning

This equipment has been tested and found to comply with the limits for a Class A digital device, pursuant to Part 15 of the FCC Rules. These limits are designed to provide reasonable protection against harmful interference when the equipment is operated in a commercial environment. This equipment generates, uses, and can radiate radio frequency energy and, if not installed and used in accordance with the Instruction manual, may cause harmful interference to radio communications. Operation of this equipment in a residential area is likely to cause harmful interference in which case the user will be required to correct the interference at his own expense.

CE Mark Warning

This is a Class A product. In a domestic environment, this product may cause radio interference, in which case the user may be required to take adequate measures.

Energy Saving Note of the Device

This power required device does not support Standby mode operation. For energy saving, please remove the power cable to disconnect the device from the power circuit. In view of saving the energy and reducing the unnecessary power consumption, it is strongly suggested to remove the power connection for the device if this device is not intended to be active.

WEEE Warning



To avoid the potential effects on the environment and human health as a result of the presence of hazardous substances in electrical and electronic equipment, end users of electrical and electronic equipment should understand the meaning of the crossed-out wheeled bin symbol.

Do not dispose of WEEE as unsorted municipal waste and have to collect such WEEE separately.

Revision

Industrial Renewable Energy 4-Port 10/100/1000T 802.3at PoE+ Managed Ethernet Switch User's Manual

Model: BSP-360

Revision: 3.0 (MAR., 2022)

Part No.: EM-BSP-360_v3.0

TABLE OF CONTENTS

1.	INTRODUCTION.....	6
1.1	Package Contents.....	6
1.2	Product Description.....	7
1.3	How to Use This Manual.....	13
1.4	Product Features	14
1.5	Product Specifications.....	16
2.	INSTALLATION.....	20
2.1	Hardware Description	20
2.1.1	Injector Front Panel.....	20
2.1.2	LED Indicators.....	21
2.1.3	Upper Panel	22
2.1.4	Fault Alarm Connectors.....	23
2.2	Installing the Renewable Energy Switch	23
2.2.1	Installation Steps.....	23
2.2.2	DIN-rail Mounting	29
2.2.3	Wall Mount Plate Mounting	31
3.	Management	32
3.1	Overview	32
3.2	Requirements.....	32
3.3	Management Method	33
3.3.1	Web Management.....	33
3.3.2	PLANET Smart Discovery Utility	36
4.	WEB CONFIGURATION	38
4.1	Main Menu	38
4.2	Web Panel	40
4.3	System.....	41
4.3.1	System Information	42
4.3.1.1	Status.....	42
4.3.1.2	Statistics.....	44
4.3.1.3	Log.....	45
4.3.2	Operation Mode.....	46
4.3.3	Time Zone	46
4.3.4	Geolocation	47
4.3.5	User Management.....	48
4.3.6	SNMP.....	49
4.3.7	Remote Management.....	50

4.4	TCP/IP	51
4.4.1	LAN	51
4.4.1.1	LAN Setup	52
4.4.1.2	Statistics	53
4.5	Battery Management.....	54
4.6	PoE Management	57
4.6.1	PoE Configuration	58
4.6.2	PoE Status	60
4.6.3	PoE Schedule	61
4.6.4	PoE Alive Check Configuration	64
4.7	ONVIF	66
4.7.1	ONVIF Device Search	67
4.7.2	ONVIF Device List.....	68
4.7.3	Preview – Snapshot	69
4.8	Maintenance	70
4.8.1	Ping.....	70
4.8.2	USB Backup.....	71
4.8.3	System Backup/Restoration	72
4.8.4	Firmware Upgrade.....	72
5.	POWER OVER ETHERNET OVERVIEW	73
6.	THE POE PROVISION PROCESS	75
6.1	Line Detection	75
6.2	Classification.....	76
6.3	Start-up	76
6.4	Operation	76
6.5	Power Disconnection Scenarios	77
APPENDIX A.	78
A.1	MDI Settings	78
A.2	Power Device Classification Values.....	78
A.3	DATA OUT PoE Injector RJ45 Port Pin Assignments.....	79
A.4	RJ45 Pin Assignment of Non-802.3af/802.3at Standard PD with PoE Mid-span PD	79
APPENDIX B.	80
B.1	Recommended Use of the Connected Wires	80
B.2	Recommended Settings for Different Batteries	80
B.3	BSP-360 Battery Default Setting.....	81

1. INTRODUCTION

1.1 Package Contents

Open the box of the Renewable Energy Switch and carefully unpack it. The box should contain the following items:

- The BSP-360 x 1
- Quick Installation Guide x 1
- Wall Mounting Kit x 1
- DIN-rail Kit x 4
- RJ45 Dust Cap x 2
- PV/Bat. 6-pin Terminal Block x 1
- DC Out 4-pin Terminal Block x 1



Note

If any of the above items are missing, please contact your seller immediately.

1.2 Product Description

Industry-leading Integration of PoE Technology and Renewable Power System

PLANET's newly-launched Renewable Energy Industrial 802.3at PoE Managed Ethernet Switch, BSP-360, is designed for deploying a surveillance or wireless network and remotely monitoring and managing the IP-based devices. Based on its green technology, the BSP-360 can be charged by the inexhaustible and natural source of energy, such as solar, wind and hydroelectric power to conserve energy so as to economically power these remote IP cameras and wireless APs, especially used for such expansive applications as dams, forests, deserts, national parks, nature/animal protection areas and highways.

PLANET NMS-360 Network Management Controller can centrally manage up to 512 BSP-360 units and 2,048 PLANET IP cameras via MQTT and ONVIF Protocols. *(Please regularly check PLANET website for the latest compatibility list of managed devices.)*



MPPT (Maximum Power Point Tracking) Charge Controller

An MPPT (Maximum Power Point Tracker) is an electronic DC to DC converter that optimizes the match between the PV solar panels and the battery bank or utility grid. They convert a higher voltage DC output from solar panels (and a few wind generators) to the lower voltage needed to charge the battery effectively. PV module can provide up to 400W of power.

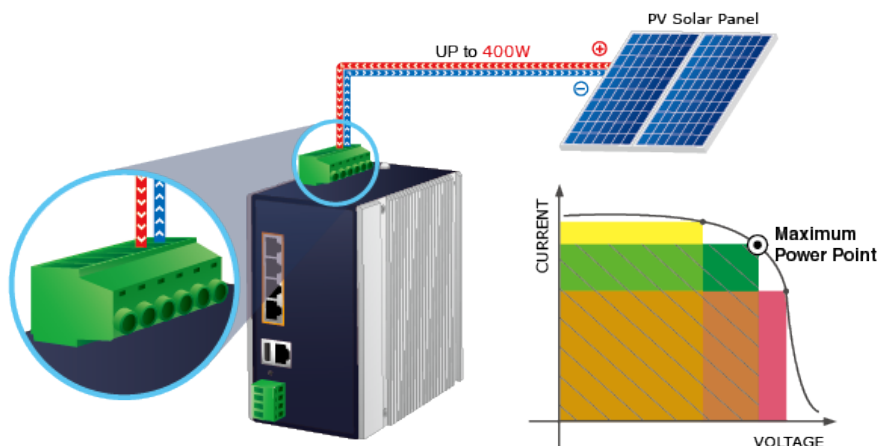

Zero-Carbon and Stable Power Supply

The 24V lithium or lead-acid battery gets recharged by way of the BSP-360 where solar power is sourced. Thus, the BSP-360 will keep powering PD devices without the need of any cabling. Its zero-carbon feature is made possible as the energy the unit gets is renewable. Most importantly, the operation of outdoor wireless IP-based surveillance can be continued into the night as the battery is charged during the day.

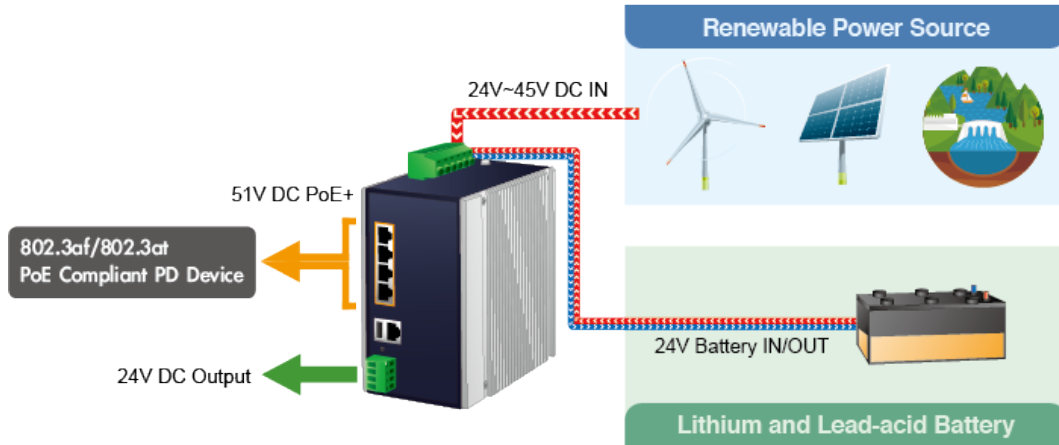

Smart Battery Management

The BSP-360 features the following special power management functions:

- Current battery usage status by percentage
- Low voltage cut-off protection
- Fully-charged hold time protection

User-friendly and Secure Management

The administrator can remotely access the BSP-360 to know the power status of the battery and renewable energy, and the estimated time of power consumption.



For efficient management, the BSP-360 is equipped with web and SNMP management interfaces. With the built-in web-based management interface, the BSP-360 offers an easy-to-use, platform-independent management and configuration facility. By supporting the standard SNMP, the switch can be managed via any standard management software.



Low Voltage Cut-Off Protection

If the remaining energy is too low to power the network, the system will automatically power off the device to make sure the system works normally, and an alert is then sent to the administrator at the same time.

Status A: Normal Operation

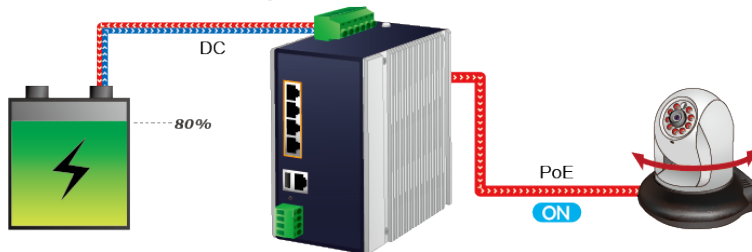

Status B: Middle Battery Capacity

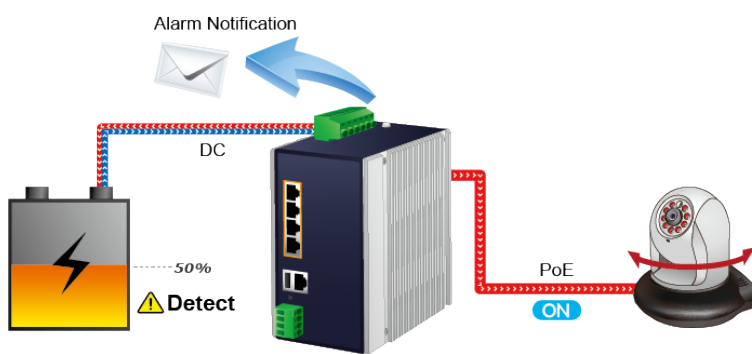

Status C: Low Battery Capacity



Smart PoE PD Management including PLANET ONVIF IP Camera

As it is the managed PoE switch for surveillance, wireless and VoIP networks, the BSP-360 features the following special PoE management functions:

- PD alive check
- Scheduled power recycling
- PoE schedule
- PoE usage monitoring

ONVIF management functions:

- Supports PLANET ONVIF IP camera discovery
- A maximum of four PLANET ONVIF IP cameras can be powered by one BSP-360 switch.
- Supports IP camera snapshot function in the LAN.

Intelligent Powered Device Alive Check

The BSP-360 can be configured to monitor connected PD (powered device) status in real time via ping action. Once the PD stops working and responding, the BSP-360 will resume the PoE port power and bring the PD back to work. It will greatly enhance the network reliability through the PoE port resetting the PD's power source and reducing administrator management burden.

PD Alive Check

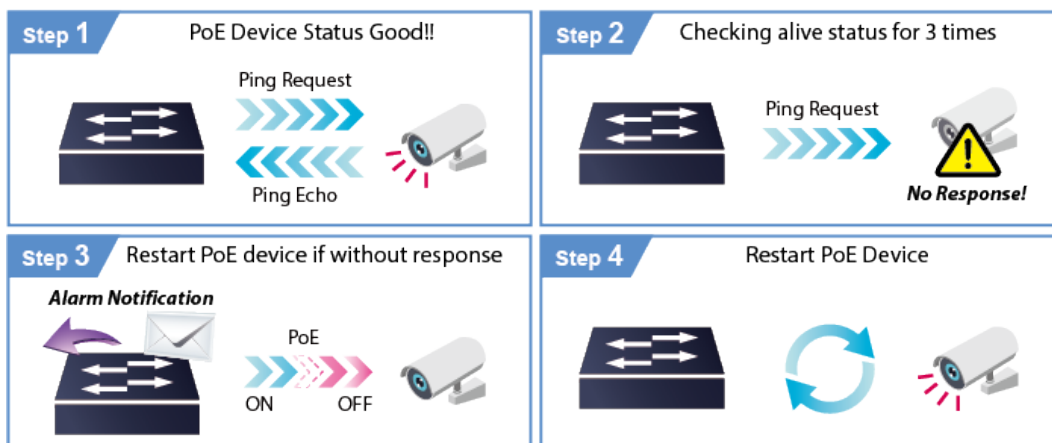

Scheduled Power Recycling

The BSP-360 allows each of the connected PoE IP cameras or PoE wireless access points to reboot at a specified time each week. Therefore, it will reduce the chance of IP camera or AP crash resulting from buffer overflow.



PoE Schedule for Energy Savings

Under the trend of energy savings worldwide and contributing to environmental protection, the BSP-360 can effectively control the power supply besides its capability of giving high watts power. The “PoE schedule” function helps you to enable or disable PoE power feeding for each PoE port during specified time intervals and it is a powerful function to help SMBs or enterprises save power and budget. It also increases security by powering off PDs that should not be in use during non-business hours.

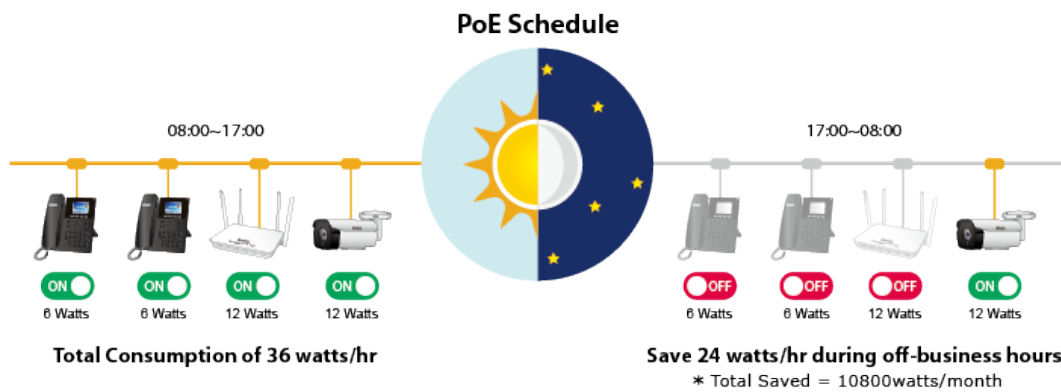

PoE Usage Monitoring and Intelligent LED Indicator for Real-time PoE Usage

Via the power usage chart in the web management interface, the BSP-360 enables the administrator to monitor the status of the power usage of the connected PDs in real time. Thus, it greatly enhances the management efficiency of the facilities. Moreover, the BSP-360 helps users to monitor the current status of PoE power usage easily and efficiently via its advanced LED indication. Called “PoE Power Usage”, the front panel of the BSP-360 has three LED indicators of different power usages.

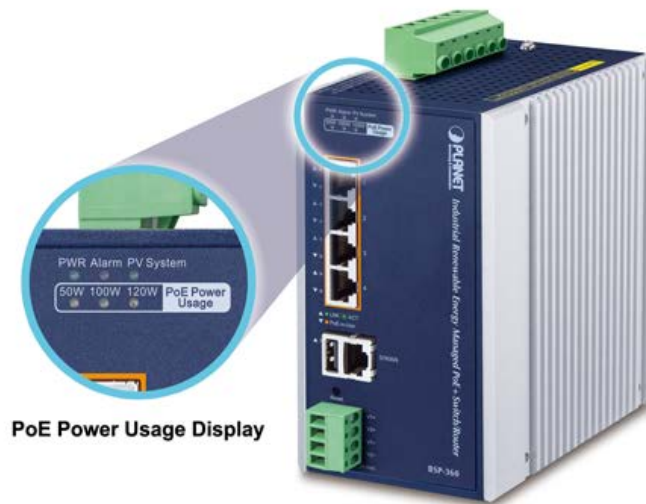

1.3 How to Use This Manual

This User Manual is structured as follows:

- **Section 2, Installation**

It explains the functions of Renewable Energy Switch and how to physically install the Renewable Energy Switch.

- **Section 3, Management**

It contains information about the software function of the Renewable Energy Switch.

- **Section 4, Web Configuration**

The section explains how to manage the Renewable Energy Switch through Web interface.

- **Section 5, Power over Ethernet overview**

The section explains the Power over Ethernet theories.

- **Section 6, PoE Power Provision Process**

The section explains the PoE power provision process.

- **Appendix A**

It contains cable information of Renewable Energy Switch.

- **Appendix B**

It contains AWG cable and battery information of Renewable Energy Switch.

1.4 Product Features

Physical Port

- 5-port 10/100/1000BASE-T Gigabit RJ45 copper with 4-port IEEE 802.3at/af PoE injector function (Port 1 to Port 4)
- RJ45 type interface for basic management and setup
- USB type A female for setting file backup and restoration

Power over Ethernet

- Complies with IEEE 802.3at Power over Ethernet Plus end-span PSE
- Backward compatible with IEEE 802.3af Power over Ethernet
- Up to 4 ports of IEEE 802.3af/802.3at devices powered
- Supports PoE power up to 36 watts for each PoE port
- Auto detects powered device (PD)
- Circuit protection prevents power interference between ports
- Remote power feeding up to 100 meters
- PoE management
 - Total PoE power budget control
 - Per port PoE function enable/disable
 - PoE port power feeding priority
 - Per PoE port power limitation
 - PD alive check
 - PoE schedule

Battery Management

- Battery type option: Lithium battery or lead-acid battery
- Easy diagnostic of the system operating status via LED indicator
- Current battery usage status
- Low voltage cut-off protection: Send alert and cut off power when the battery is low
- MPPT (Maximum Power Point Tracking) Charge Controller
 - Reverse current protection to prevent the current circuits from flowing back to the PV panel
 - Over-current protection
 - Reverse polarity protection (for battery and charging electrodes)

Industrial Case and Installation

- IP30 aluminum case
- DIN-rail and wall-mounted designs
- Supports -10 to 60 degrees C operating temperature
- Supports ESD 6KV DC Ethernet protection
- Redundant power supply
- 24V~45V DC wide power input

Switching

- Hardware-based 10/100Mbps (half/full duplex), 1000Mbps (full duplex), auto-negotiation and auto MDI/MDI-X
- Features Store-and-Forward mode with wire-speed filtering and forwarding rates
- IEEE 802.3x flow control for full duplex operation and back pressure for half duplex operation
- 8K MAC address table size
- Automatic address learning and address aging

Router

- Internet types: Dynamic IP, static IP, PPPoE, L2TP, PPTP
- Static and dynamic (RIP1 and 2) routing
- IP/MAC-based bandwidth control
- Supports Port Forwarding, DMZ, UPnP and Dynamic DNS for various networking applications
- 802.1d STP and IGMP Proxy

Security

- Port filtering allows which application can access the Internet.
- MAC filtering allows you to include or exclude computers and devices based on their MAC address
- URL filtering allows you to control access to Internet websites in an URL list
- IP source guard prevents IP spoofing attacks
- DoS attack prevention

Management

- Switch Management Interface
- - IPv4 Web switch management
- - SNMP v1, v2c
- Static and DHCP for IP address assignment
- System Maintenance
- - Firmware upload/download via HTTP
- - Configuration upload/download through HTTP
- - Hardware-based reset button for system reboot or reset to factory default
- Network Time Protocol
- SNMP trap for Link Up and Link Down notifications
- Event message logging to remote syslog server
- Supports PLANET ONVIF IP camera and snapshot function
- PLANET Smart Discovery Utility
- Supports PLANET NMS-360 Network Management Controller

1.5 Product Specifications

Product	BSP-360
Hardware Specifications	
Copper Ports	LAN: 5 10/100/1000Mbps auto MDI/MDI-X RJ45 port (Port 1 to Port 5, bridge mode) WAN: 1 10/100/1000Mbps auto MDI/MDI-X RJ45 port (Port 5, gateway mode)
PoE Injector Port	4 ports with 802.3af/802.3at PoE injector function (Port 1 to Port 4)
USB	1 USB Type A female for setting backup
Power Output	4 PoE out 51VDC; max. 36 watts per PoE port 2 DC out 24@ 2A maximum (four-pin terminal block) * The voltage of DC out is based on the battery.
Reset Button	< 5 sec: System reboot > 10 sec: Factory default
Connector	Removable 6-pin terminal block Pin 1/2 for PV panel; Pin 3/4 for alarm; Pin 5/6 for battery
Alarm	1 digital output (DO): Level 0: -24V~2.1V (±0.1V) Level 1: 2.1V~24V (±0.1V) Open collector to 24V DC, 100mA max.
Power Requirements	PV in: 24~45V DC Battery in/out: 24V DC
Power Consumption/ Dissipation	5.04 watts, 17.1BTU (Standby without PoE function) 6.96 watts, 23.7 BTU (Full loading without PoE function) 135.36 watts, 461.5 BTU (Full loading with PoE function)
Dimensions (W x D x H)	89 x 107 x 152 mm
Weight	1251g
ESD Protection	6KV DC
Enclosure	IP30 aluminum case
Installation	DIN-rail kit and wall-mount ear
LED Indicators	3 LEDs for System and Power: - Green : Power - Red : Alarm - Green : PV System 4 LEDs for PoE Copper Ports (Port 1~Port 4): - Green : LNK/ACT - Amber : PoE-in-use 1 LED for 10/100/1000T Copper Port (Port 5): - Green : LNK/ACT 3 LEDs for PoE Power Usage (W)

	- Amber : 50, 100 and 120W	
Switching Specifications		
Switch Architecture	Store-and-Forward	
Switch Fabric	10Gbps/non-blocking	
Switch Throughput@64 bytes	5.95Mpps@64 bytes	
MAC Address Table	8K entries	
Shared Data Buffer	512Kbit	
Flow Control	IEEE 802.3x pause frame for full duplex Back pressure for half duplex	
Power over Ethernet		
PoE Standard	IEEE 802.3af/802.3at Power over Ethernet PSE	
PoE Power Supply Type	End-span	
PoE Power Output	Per port 51V DC, 275mA. Max. 15.4 watts (IEEE 802.3af) Per port 51V DC, 535mA. Max. 36 watts (IEEE 802.3at)	
Power Pin Assignment	1/2 (+), 3/6 (-)	
PoE Power Budget	120 watts (PoE consumption + DC out and depending on power input)	
Max. Number of Class 2 PDs	4	
Max. Number of Class 3 PDs	4	
Max. Number of Class 4 PDs	4	
Renewable Power Input (PV IN)		
Min. Voltage	24V (Suggest > 30V for fully charge to battery)	
Max. Voltage	45V	
Max. Current	< 8.8A	
Max. Power	< 400W	
Battery Information		
Type	Lithium Battery (Default)	Lead-acid Battery
FCV	fixed 26.6V	27.2 V (26.0~30.0)
ACV	fixed 28.7V	29.2 V (28.0~32.0)
LVD (Low Voltage Disconnection)	21.3V (19.6~23.0V)	22.2 V (21.0~23.0)
LVR (Low Voltage Reconnection)	24.0V(23.5~25.0)	23.5 V (23.5~27.0)
Router Features		
Internet Connection Type	Shares data and Internet access with users, supporting the following internet accesses: - PPPoE - Dynamic IP - Static IP - PPTP - L2TP	

Firewall	NAT firewall with SPI (Stateful Packet Inspection) Built-in NAT server supporting Port Forwarding, and DMZ Built-in firewall with IP address/MAC address/Port/ URL filtering Supports ICMP-FLOOD, UDP-FLOOD, TCP-SYN-FLOOD filter, DoS protection
Routing Protocol	Static/Dynamic (RIP1 and 2) routing
VPN Pass-through	PPTP, L2TP, IPSec, IPv6
LAN	Built-in DHCP server supporting static IP address distribution Supports UPnP, Dynamic DNS Supports IGMP Proxy Supports 802.1d STP (Spanning Tree) IP/MAC-based bandwidth control
Management	
Management Interface	Setting up of system/management functions Web firmware upgrade SNMP trap for alarm notification of events
PoE Management	Power limit by consumption and allocation PoE admin mode Per port power schedule Per port power enable/disable Power feeding priority Current per port usage and status Total power consumption PD alive check Scheduled power recycling
Battery Management	Current battery usage status Low voltage cut-off protection Fully-charged hold time protection
PLANET ONVIF IP Camera Management	Supports PLANET ONVIF IP camera discovery A maximum of four PLANET ONVIF IP cameras can be powered by one BSP-360 switch. Supports IP camera snapshot function in the LAN.
Standards Conformance	
Regulatory Compliance	FCC Part 15 Class A, CE
Standards Compliance	IEEE 802.3 10BASE-T Ethernet IEEE 802.3u 100BASE-TX Fast Ethernet IEEE 802.3ab 1000BASE-T Gigabit Ethernet IEEE 802.3x Flow Control and Back Pressure IEEE 802.1D Spanning Tree Protocol IEEE 802.3af Power over Ethernet IEEE 802.3at Power over Ethernet Plus RFC 768: UDP RFC 791: IP

	RFC 2068 HTTP RFC 1157: SNMP v1 RFC 1902: SNMP v2c RFC 5424: Syslog
Environment	
Operating	Temperature: -10 ~ 60 degrees C Relative Humidity: 5 ~ 95% (non-condensing)
Storage	Temperature: -10 ~ 70 degrees C Relative Humidity: 5 ~ 95% (non-condensing)

2. INSTALLATION

This section describes the hardware features of Renewable Energy Switch. For easier management and control of the Renewable Energy Switch, familiarize yourself with its display indicators and ports. Front panel illustrations in this chapter display the unit LED indicators. Before connecting any network device to the Renewable Energy Switch, read this chapter carefully.

2.1 Hardware Description

The section describes the hardware of the Renewable Energy Switch and gives a physical and functional overview.

2.1.1 Injector Front Panel

Dimensions (W x D x H)	152 x 107 x 89 mm
Weight	1251g (gross weight)

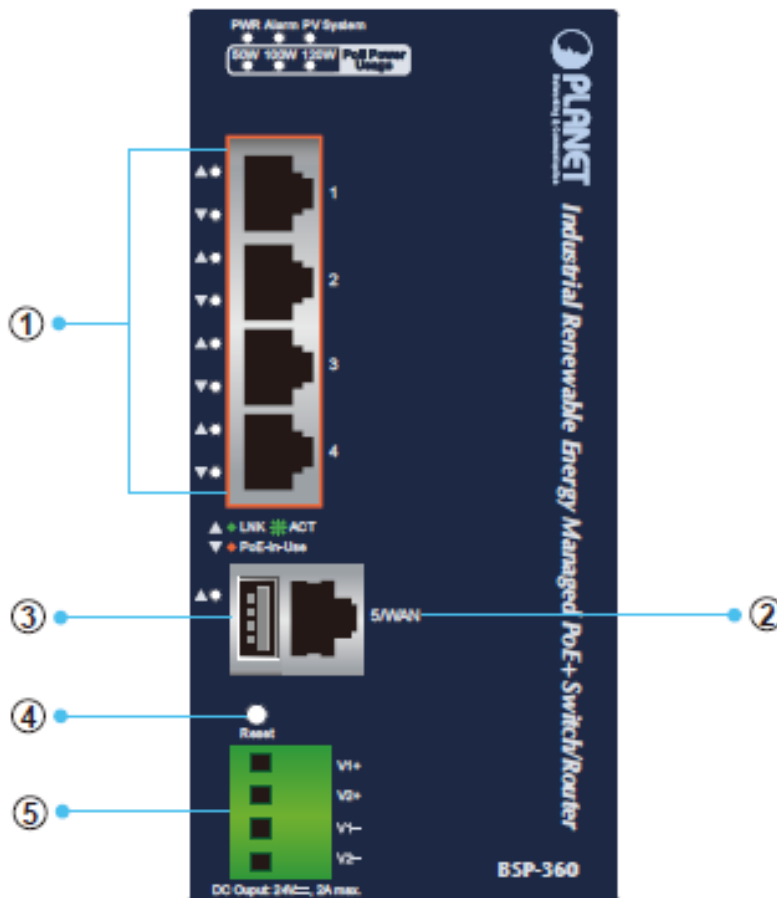

Item	Interface	Description
1	Port-1~Port-4	4 10/100/1000BASE-T RJ45 auto-MDI/MDI-X ports with 802.af/at PoE+ injector function.
2	Port-5	One 10/100/1000BASE-T RJ45 auto-MDI/MDI-X port. Port-5 functions as WAN port when the operation mode of BSP-360 is configured to " Gateway mode "
3	USB	Connect the USB storage to USB port and back up the configuration file.
4	Reset Button	< 5 seconds: System reboot. > 10 seconds: Factory default.
5	4-pin Terminal Block	2 x 24V 2A DC output connector. The output voltage is the same as battery voltage. Maximum power output is clamped at 48W.

2.1.2 LED Indicators

The front panel LEDs indicates instant status of system power, PoE and PV system, management port Link/Active, PoE power usage status and per PoE port links status, thus helping administrator to monitor and troubleshoot when needed.

System

LED	Color	Function	
PWR	Green	On	To indicate BSP-360 has power.
Alarm	Red	Slow Blinks	To indicate PV < 24V.*
		Fast Blinks	To indicate battery Voltage ≤ LVD.*
PV System	Green	Slow Blinks	To indicate the system is " Not Charging ".
		Fast Blinks	To indicate the battery is " Charging ".
50W	Amber	On	To indicate the system consumes over 50-watt PoE power budget.
100W	Amber	On	To indicate the system consumes over 100-watt PoE power budget.
120W	Amber	On	To indicate the system consumes the total 120-watt PoE power budget.

*The detection voltage will have a tolerance of +-0.7V.

PoE 10/100/1000BASE-T Interfaces (Port-1 to Port-4)

LED	Color	Function	
LNK/ACT	Green	Blinks	To indicate the link through that port is successfully established.
PoE	Amber	Lights	To indicate the port is providing DC in-line power.
		Off	To indicate the connected device is not a PoE powered device (PD).

10/100/1000BASE-T Interfaces (Port-5)

LED	Color	Function	
LNK/ACT	Green	Blinks	To indicate the link through that port is successfully established.

2.1.3 Upper Panel

The Upper Panel of the Renewable Energy Switch comes with a DC inlet power socket and one terminal block connector with 6 contacts.

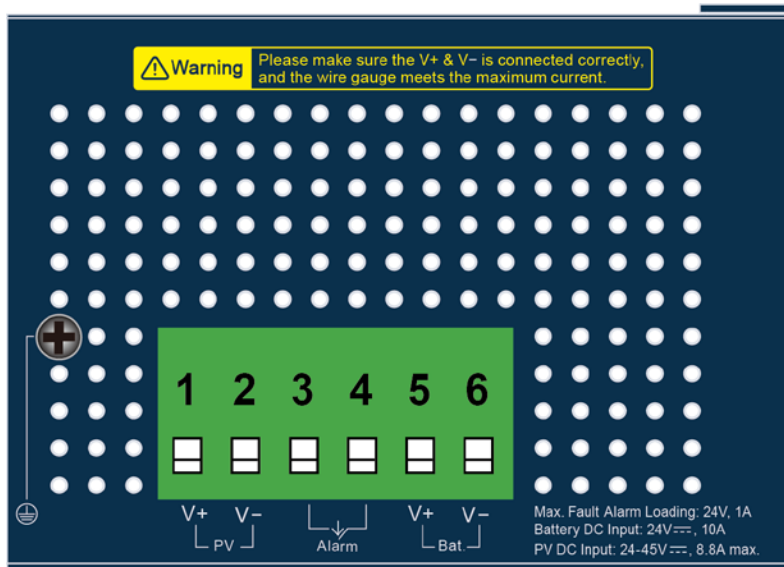

PV In Connector

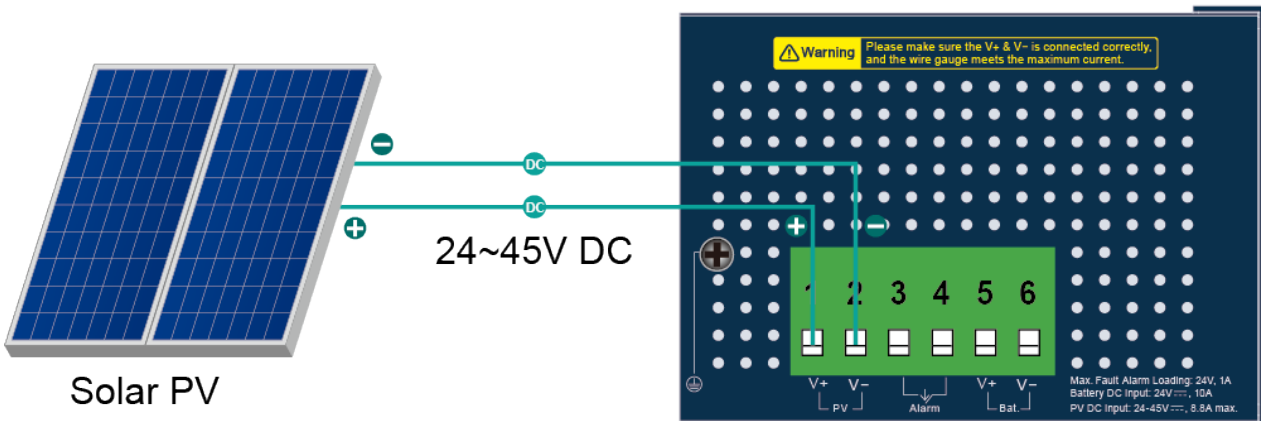

Battery In/Out

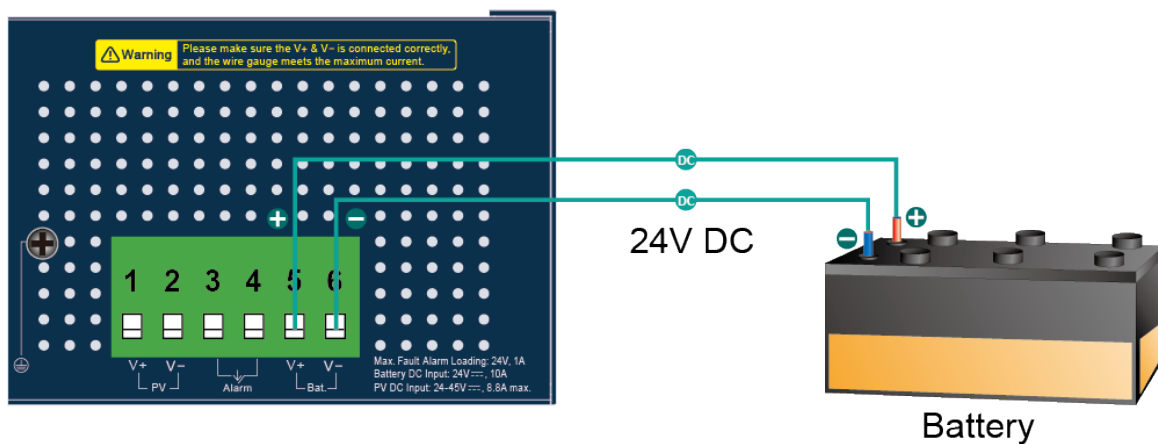

The wire gauge for the terminal block should be in the range from **16 to 20 AWG**.

2.1.4 Fault Alarm Connectors

The fault alarm contacts are in the middle (3 & 4) of the terminal block connector as the picture shows below. Inserting the wires, the Renewable Energy Switch will detect the fault status of the power failure.

*When the system is “ON”, the fault alarm is “off”.

*When the system is “OFF”, the fault alarm will “trigger”.

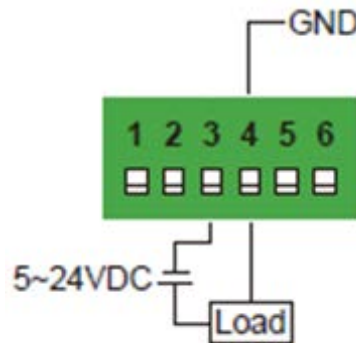

Note

1. The wire gauge for the terminal block should be in the range of **16 ~ 20 AWG**.
2. When performing any of the procedures like inserting the wires or tightening the wire-clamp screws, make sure the power is OFF to prevent from getting an electric shock.

2.2 Installing the Renewable Energy Switch

This section describes how to install your Renewable Energy Switch and make connections to the Renewable Energy Switch. Please read the following sections and perform the procedures in the order being presented.

To install your Renewable Energy Switch on a desktop or shelf, simply complete the following steps.

In this paragraph, we will describe how to install the Renewable Energy Switch and the installation points attended to it.

2.2.1 Installation Steps

The following section describes the hardware installation of the BSP-360. Before connecting any network device to the BSP-360, read this chapter carefully.

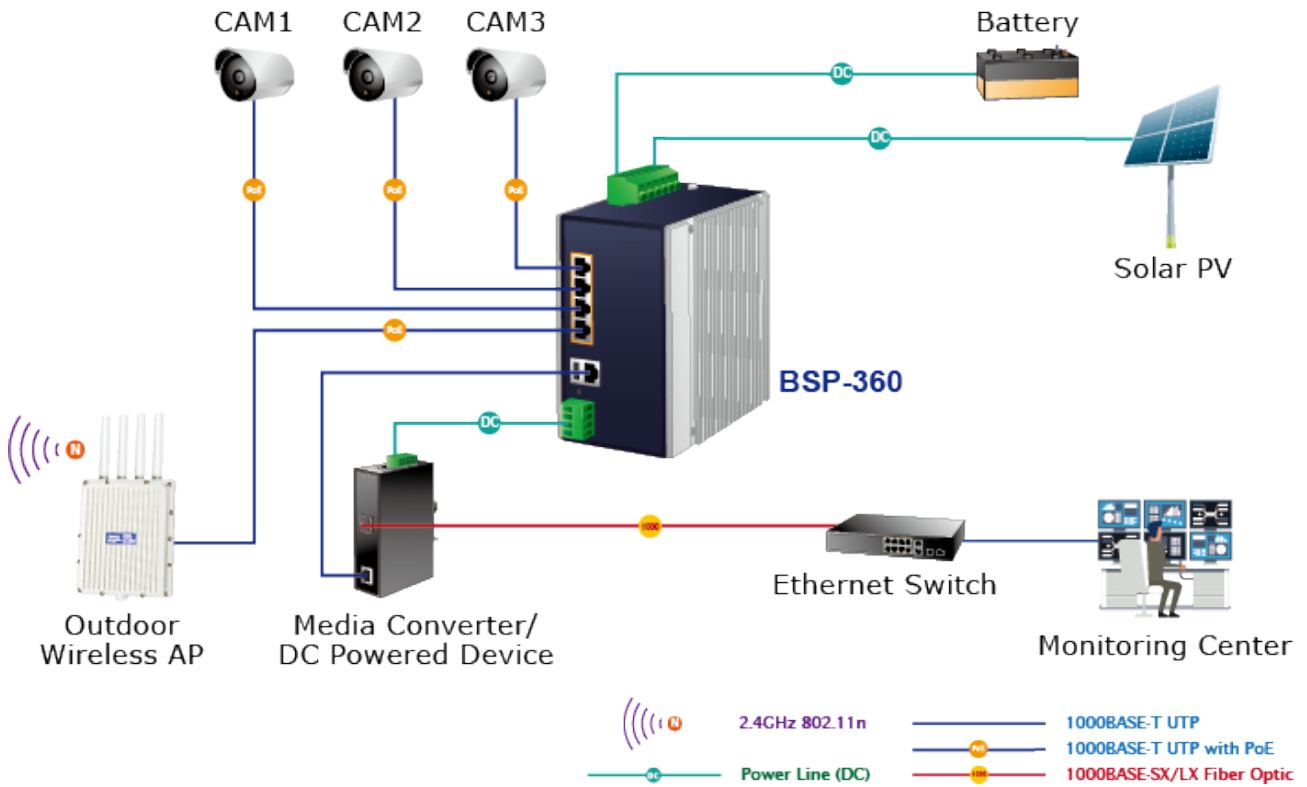

Please follow the following steps to install the system:

Step 1. Installing BSP-360

Place the BSP-360 in a desired location using the wall-mount or DIN-rail fixtures.



- a. Please install the BSP-360 in a proper enclosure or shelter.
- b. The BSP-360 must be grounded.

Step 2. Installing Battery



- (1) Connect the **negative electrode of the battery** to the terminal for the **negative electrode of the battery on the BSP-360**. By default, the lithium battery is in use.
- (2) Connect the **positive electrode of the battery** to the terminal for the **positive electrode of the battery on the BSP-360**.
- (3) After the battery is well connected to the BSP-360, the **PWR LED will be ON** and **System LED will slowly blink**, and **Alarm LED will slowly blink**.



The BSP-360 accepts the **24V DC** battery system. Please pay attention to the battery characteristics and also refer to the section -- **Recommended Settings for Different Batteries** in the Quick Installation Guide.

- Be noted for the thickness of electric wire and please refer to the section -- **Recommended Use of the Connected Wires** in the Quick Installation Guide.

- **Before the first installation**



- The lead-acid battery default **LVD (Low Voltage Disconnection)** is set at **22.2V DC**; we suggest charging the voltage of battery to **23.5V DC or above** for the BSP-360.
 - The lithium battery default **LVD (Low Voltage Disconnection)** is set at **21.3V DC**; we suggest charging the voltage of battery to **24V DC or above** for the BSP-360.
-



Check the total power consumption of your connected network device before installation. Improper battery capacity could shorten the battery life or could not supply enough power to your network device.



Please click on **PLANET Download Center** and download **BSP360-PV&BAT_calculation**. The calculation list can help you to select solar panel and battery. Refer to Section 6 for customer support.

Step 3. Installing PV Panel



- (1) Connect the **negative electrode of the PV panel** to the terminal for the **negative electrode of the PV panel on the BSP-360**.
- (2) Connect the **positive electrode of the PV panel** to the terminal for the **positive electrode of the PV panel on the BSP-360**.
- (3) After the PV is well connected to the BSP-360 and providing 24V or above voltage, the **System LED will blink fast for battery charge if the battery is not full**.



- Be noted for the thickness of electric wire and please refer to the section -- **Recommended Use of the Connected Wires** in the Quick Installation Guide.
- Check the total power consumption of your device and the sunshine duration of your area from the weather bureau for a proper PV. Improper PV could shorten the battery life or provide insufficient power to the BSP-360.



The BSP-360 supports a maximum of **45V 8.8A DC input**.

Step 4. Connecting 802.3af/802.3at PoE Device

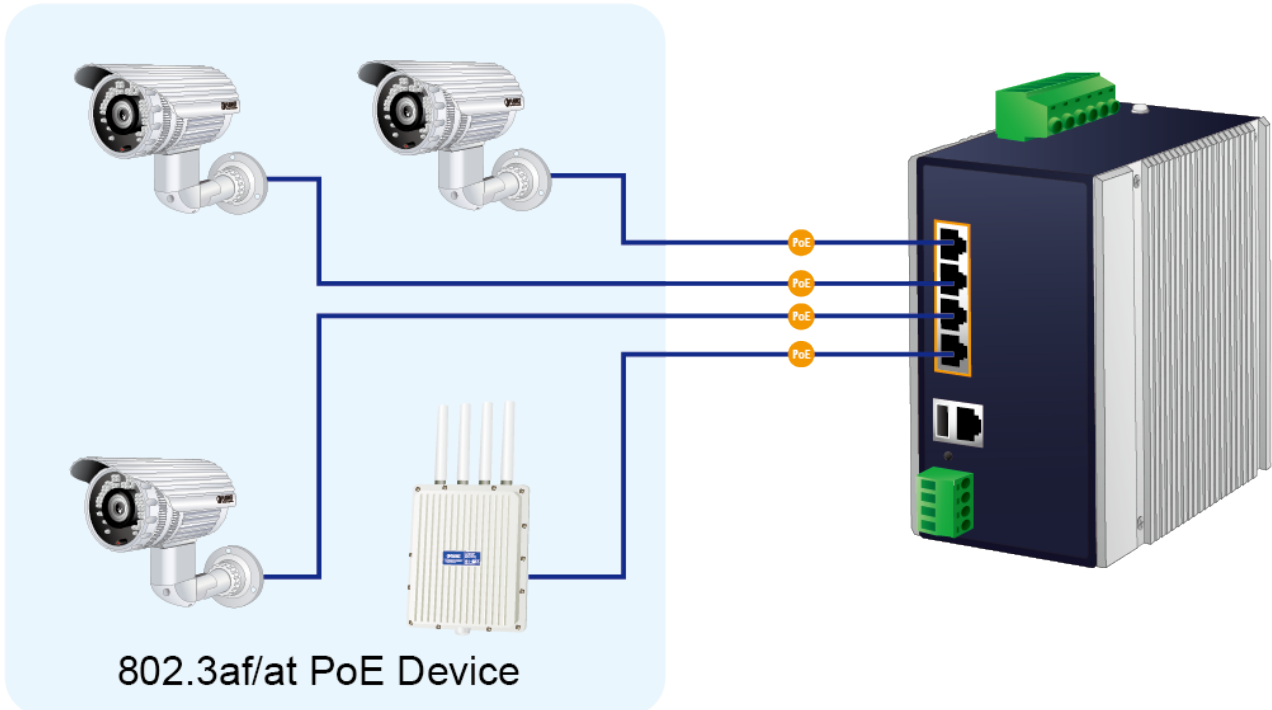

- (1) Connect the PoE devices to ports 1~ 4 on the BSP-360.
- (2) Check the PoE-in-Use LED. If the network devices such as PoE camera and PoE wireless AP are powered, the **PoE-in-use LED will turn ON** and **Link/Act LED will blink** for a successful connection or data receiving.



Note

- Please use **Cat5/5e or above cable** and the maximum distance should be within **100 meters**.
- If the network devices are installed outdoors, please consider to install a well-grounded lightning arrester (such as PLANET ELA-100) to protect the network device and the BSP-360.

Step 5. Wiring the DC Outputs

Please follow the steps below to insert the power wires for DC power required equipment.

- (1) Please find the terminal block connector with two DC power outputs shown below:

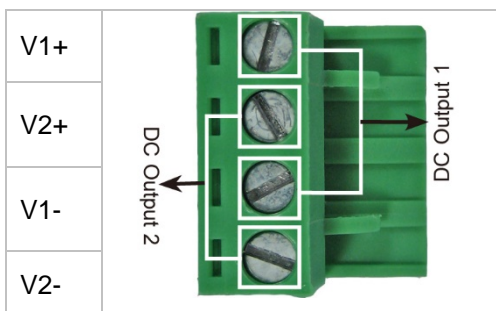

- (2) Insert the **Positive and Negative DC wires** into the **V+ and V- terminals**, respectively; Terminals 1 and 3 for Power 1, and Terminals 2 and 4 for Power 2.

- (3) Connect the other points of DC power wires to the power devices. Tighten the wire-clamp screws for preventing the wires from loosening.

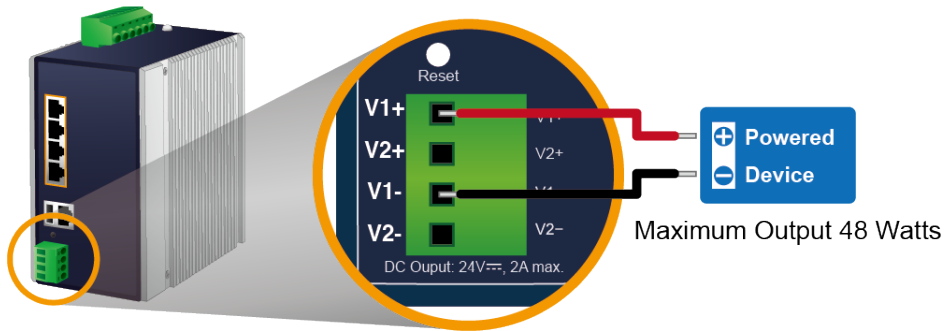

One Powered Device

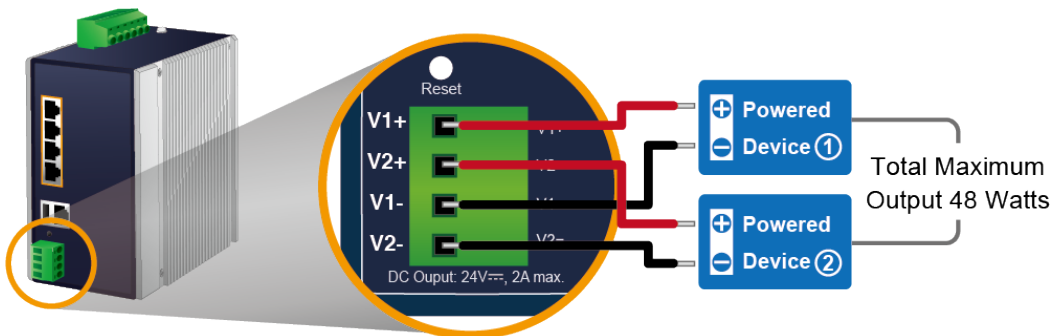

Two Powered Devices

- (4) Install the terminal block on the BSP-360.



Note

- The voltage of DC out is based on the battery voltage and the maximum DC out from the BSP-360 is **24VDC, 2A**.
- The wire gauge for the terminal block should be in the range from **16 to 20 AWG**.
- The external device should also be grounded properly.



Please ensure the output voltage is correct for remote device. Otherwise, it will damage your remote device.

Step 6. Connecting to PC or Your Remote Ethernet Network

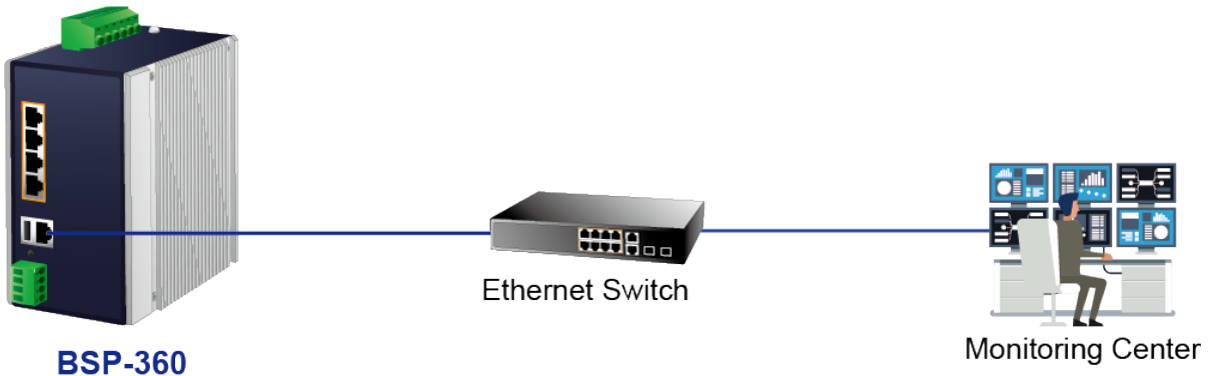

After completing the above 6 steps, the BSP-360 is ready for service.

2.2.2 DIN-rail Mounting

This section describes how to install the Renewable Energy Switch. There are two methods to install the Renewable Energy Switch -- DIN-rail mounting and wall-mount plate mounting. Please follow the steps below.



Follow all the DIN-rail installation steps as shown in the example.

Step 1: Screw the DIN-rail on the **Renewable Energy Switch**.



Step 2: Lightly slide the DIN-rail into the track.



Step 3: Check whether the DIN-rail is tightly on the track.

Please refer to the following steps to remove the Renewable Energy Switch from the track.

Step 4: Lightly remove the DIN-rail from the track.



2.2.3 Wall Mount Plate Mounting

To install the Renewable Energy Switch on the wall, please follow the instructions below.

 Note	Follow all the DIN-rail installation steps as shown in the example.
---	--

Step 1: Remove the DIN-rail from the Renewable Energy Switch. Use the screwdriver to loosen the screws to remove the DIN-rail.

Step 2: Place the wall-mount plate on the rear panel of the Renewable Energy Switch.



Step 3: Use the screwdriver to screw the wall mount plate on the Renewable Energy Switch.

Step 4: Use the hook holes at the corners of the wall mount plate to hang the Renewable Energy Switch on the wall.

Step 5: To remove the wall mount plate, reverse the steps above.

3. MANAGEMENT

This chapter describes how to manage the Renewable Energy Switch with the following topics included:

- Overview
- Requirements
- Management Method

3.1 Overview

The Renewable Energy Switch provides a user-friendly, Web interface where you can perform various device configuration and management activities, including:

- **System**
- **SNMP**
- **Power over Ethernet**
- **Battery Management**

3.2 Requirements

PLANET BSP-360 provides a remote login interface for management purposes. The following equipment is necessary for further management:

- **Workstation** is installed with Ethernet NIC (Network Interface Card)
- Choice of Internet browsers includes Windows XP/2003, Vista, Windows 7, Windows 8, Windows 10, Windows 11, MAC OS X, Linux, Fedora, Ubuntu or other platforms compatible with TCP/IP protocols.
 - The above workstation is installed with Web browser and JAVA runtime environment plug-in.
- **Ethernet Port** connection
 - Use standard network (UTP) cables with RJ45 connectors.
- **PV and battery**
 - Either two 12V lithium or lead-acid batteries, or one 24V lithium or lead-acid battery can be used.
 - The maximum operating voltage of PV is 45V



It is recommended to use Chrome 98.0.xxx or above to access the BSP-360.

3.3 Management Method

User can manage the Renewable Energy Switch by Web Management via a network connection.

3.3.1 Web Management

The following shows how to start up the **Web Management** of the BSP-360. Note the BSP-360 is configured through an Ethernet connection. Please make sure the manager PC must be set to the same **IP subnet address**.

For example, the default IP address of the BSP-360 is **192.168.0.100**, then the manager PC should be set to **192.168.0.x** (where x is a number between 1 and 254, except 100), and the default subnet mask is 255.255.255.0.

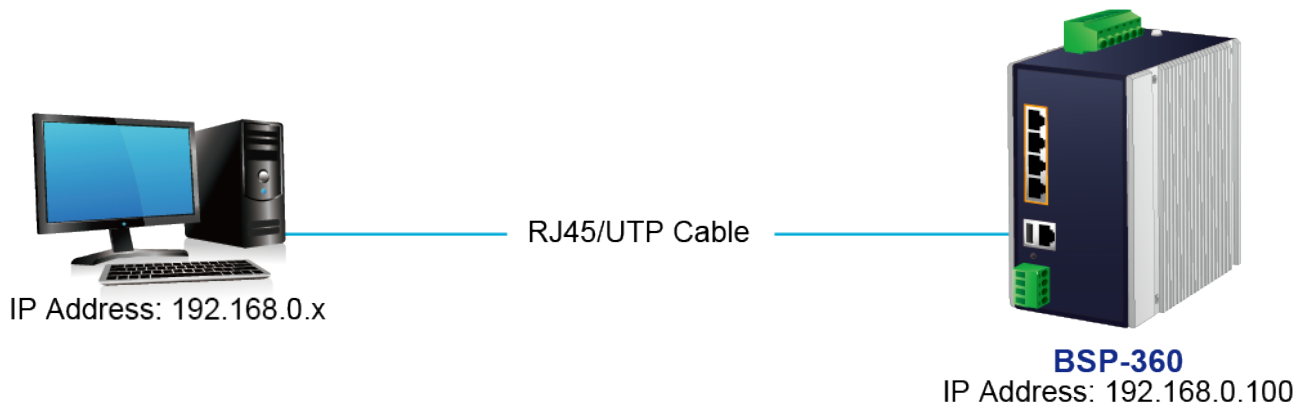

Logging in to the BSP-360

Step 1. Use Internet Explorer 8.0 or above for Web browser and enter IP address <http://192.168.0.100> (the factory default IP address) to access the Web interface.

Step 2. When the following dialog box appears, please enter the default user name "admin" and password "admin" (or the password you have changed before).

Default IP Address: **192.168.0.100**

Default User Name: **admin**

Default Password: **admin**

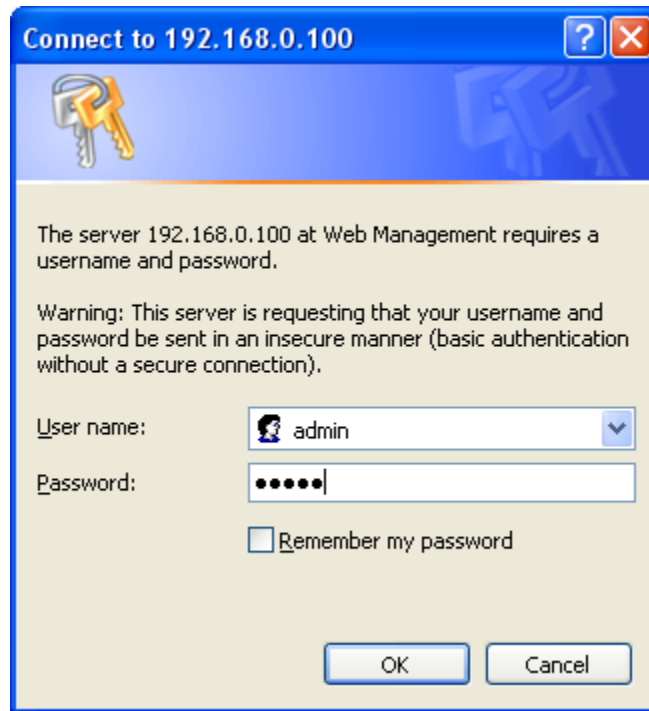

Step 3. After entering the password, the main screen appears. The above banner shows the information of Green Power ,Total Power Usage, PoE Usage and Battery Capacity.



Step 4. The Function Menu on the left of the Web page lets you access all the functions and status the BSP-360 provides.

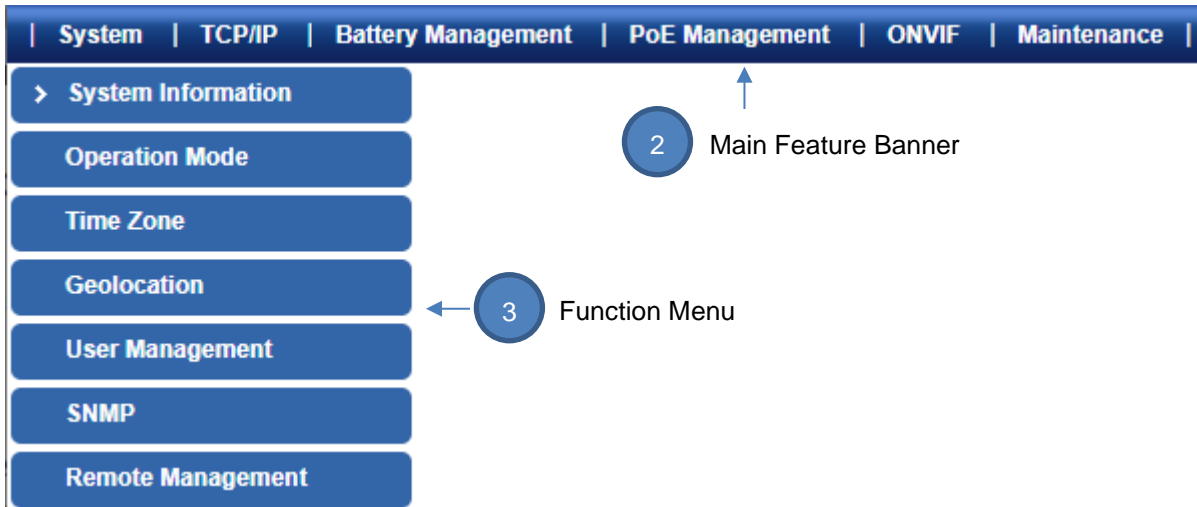

Now, you can use the Web management interface to continue the BSP-360 management. Please refer to the user manual for more details.



For security reason, please change and memorize the new password after this first setup.

3.3.2 PLANET Smart Discovery Utility

For easily listing the Renewable Energy Switch in your Ethernet environment, Planet Smart Discovery Utility from PLANET download center is an ideal solution. The following installation instructions guide you to running Planet Smart Discovery Utility. Download Planet Smart Discovery Utility from the download center. Run this utility and the following screen appears.

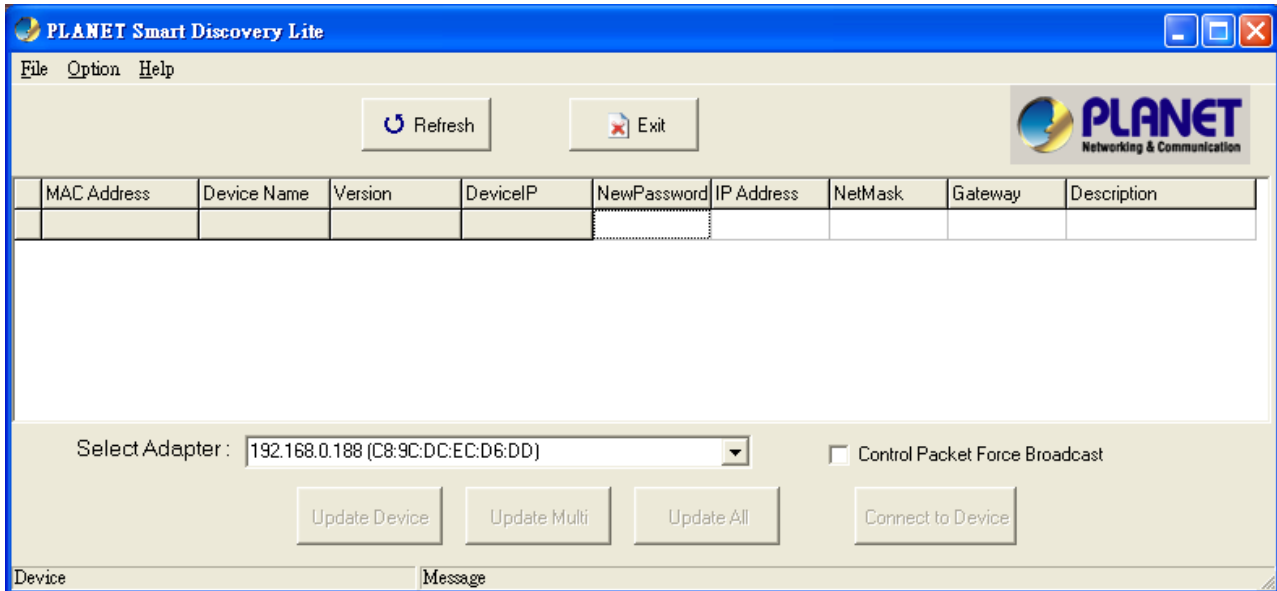



Figure 3-3-3: Planet Smart Discovery Utility Screen



If there are two LAN cards or above in the same administrator PC, choose a different LAN card by using the “**Select Adapter**” tool.

Press the “**Refresh**” button for the currently-connected devices in the discovery list and the screen is shown as follows:

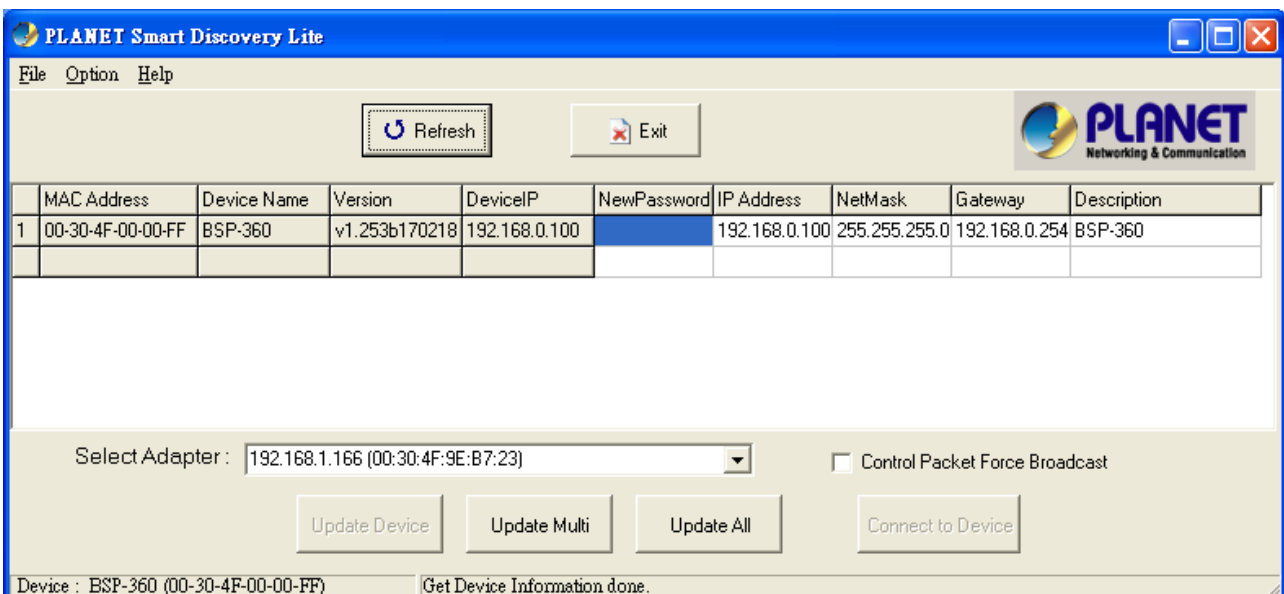

Figure 3-3-4: Planet Smart Discovery Utility Screen

This utility shows all necessary information from the devices, such as MAC address, device name, firmware version and device IP subnet address. It can also assign new password, IP subnet address and description of the devices.

After setup is completed, press the **“Update Device”**, **“Update Multi”** or **“Update All”** button to take effect. The definitions of the 3 buttons above are shown below:

Update Device: Use the current setting on one single device.

Update Multi: Use the current setting on multi-devices.

Update All: Use the current setting on all devices in the list.

The same functions mentioned above also can be found in **“Option”** tools bar.

By clicking the **“Control Packet Force Broadcast”** function, it allows you to assign new setting value to the Ultra PoE Managed Injector Hub under a different IP subnet address.

Press the **“Connect to Device”** button and then the Web login screen appears in [Figure 3-3-2](#).

Press the **“Exit”** button to shut down Planet Smart Discovery Utility.

4. WEB CONFIGURATION

The Renewable Energy Switch provides Web interface for PoE smart function configuration and makes the Renewable Energy Switch operate more effectively. They can be configured through the Web browser. A network administrator can manage and monitor the Renewable Energy Switch from the local LAN. This section indicates how to configure the Renewable Energy Switch to enable its smart function.

4.1 Main Menu

After a successful login, the main screen appears. The main screen, as shown in [Figure 4-1-1](#), displays the

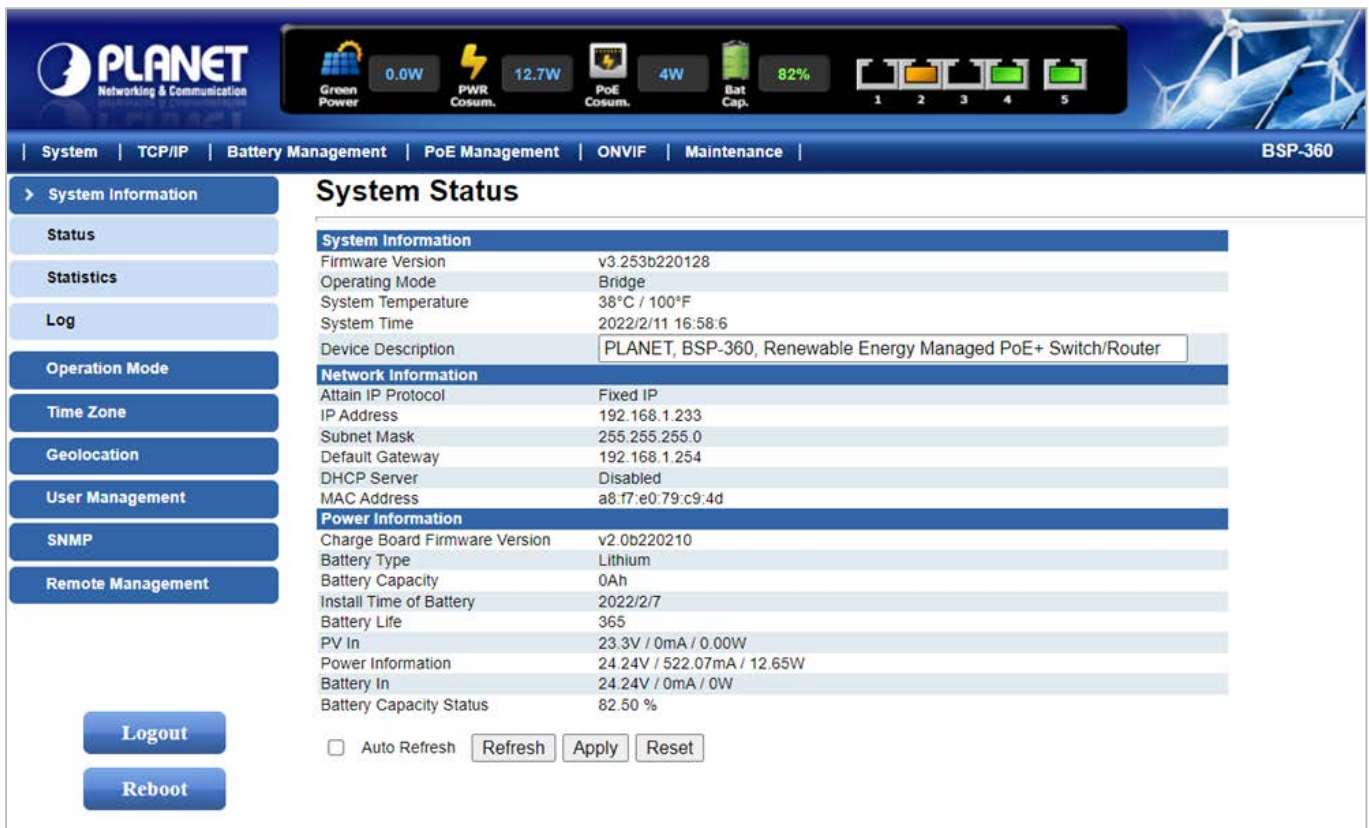

The screenshot displays the Planet BSP-360 web interface. At the top, there is a navigation bar with the Planet logo and a menu: System | TCP/IP | Battery Management | PoE Management | ONVIF | Maintenance. The main content area is titled 'System Status' and is divided into three sections: System Information, Network Information, and Power Information. On the left, there is a sidebar with various management options like Status, Statistics, Log, Operation Mode, Time Zone, Geolocation, User Management, SNMP, and Remote Management, along with Logout and Reboot buttons.

System Information	
Firmware Version	v3.253b220128
Operating Mode	Bridge
System Temperature	38°C / 100°F
System Time	2022/2/11 16:58:6
Device Description	PLANET, BSP-360, Renewable Energy Managed PoE+ Switch/Router

Network Information	
Attain IP Protocol	Fixed IP
IP Address	192.168.1.233
Subnet Mask	255.255.255.0
Default Gateway	192.168.1.254
DHCP Server	Disabled
MAC Address	a8:f7:e0:79:c9:4d

Power Information	
Charge Board Firmware Version	v2.0b220210
Battery Type	Lithium
Battery Capacity	0Ah
Install Time of Battery	2022/2/7
Battery Life	365
PV In	23.3V / 0mA / 0.00W
Power Information	24.24V / 522.07mA / 12.65W
Battery In	24.24V / 0mA / 0W
Battery Capacity Status	82.50 %

At the bottom of the System Status section, there are controls: Auto Refresh, Refresh, Apply, and Reset.

product name, the function menu, and the main information in the center.

Figure 4-1-1: Web Main Menu screen

The descriptions of the four items are as follows:

Object	Description
System	Provides System information of Renewable Energy Switch. Explained in section 4.3
TCP/IP	Provides WAN, LAN and network configuration of Renewable Energy Switch. Explained in section 4.4
Battery Management	Provides Battery Management configuration of Renewable Energy Switch. Explained in section 4.5
PoE Management	Provides PoE Management configuration of Renewable Energy Switch. Explained in section 4.6
ONVIF	Provides management of PLANET ONVIF IP camera and snapshot function. Explained in section 4.7
Maintenance	Provides firmware upgrade and setting file restore/backup configuration of Renewable Energy Switch. Explained in section 4.8.

4.2 Web Panel

At the top of the Web management page, the active panel displays the power status and the link status of management port and PoE ports.



Figure 4-2-1: Web Panel Screen













Object	Icon	Function
DC IN		To indicate the Power of DC in.
Bat Cap.		To indicate the battery capacity is 70~100%.
		To indicate the battery capacity is 70~100% and the battery is being charged by solar PV.
		To indicate the battery capacity is 40~69%.
		To indicate the battery capacity is 40~69% and the battery is being charged by solar PV.
		To indicate the battery capacity is 1~39%.
		To indicate the battery capacity is 1~39% and the battery is being charged by solar PV.
PWR Cosum.		To indicate the total power consumption.
PoE Cosum.		To indicate the PoE consumption.
LAN		To indicate the port is not connected.
		To indicate the PoE is in use.
		To indicate the PoE port is disabled.
		To indicate network data is sending or receiving

Table 4-2-1: Descriptions of the Web Panel Objects

4.3 System

The System function provides system information which also allows user to manage the Renewable Energy Switch system as [Figure 4-3-1](#) is shown below:



Figure 4-3-1: System Function Menu

The page includes the following information:

Object	Description
System Information	Display the System Status, Statistics, System Log. Explained in section 4.3.1.
Operation Mode	Show the current operation mode, and users can set different modes to LAN interface. Explained in section 4.3.2.
Time Zone	Allow to set system time by manual or synchronize system time from Internet NTP server. Explained in section 4.3.3.
Geolocation	Configure the device location latitude, longitude, and altitude. Explained in section 4.3.4.
User Management	Allow to change the username and password of Renewable Energy Switch. Explained in section 4.3.5.
SNMP	Provides SNMP Trap information and system information. Explained in section 4.3.6.
Remote Management	Provides SNMP Trap information and system information. Explained in section 4.3.7.

4.3.1 System Information

This section displays system information of Renewable Energy Switch as Figure 4-3-2 is shown below:

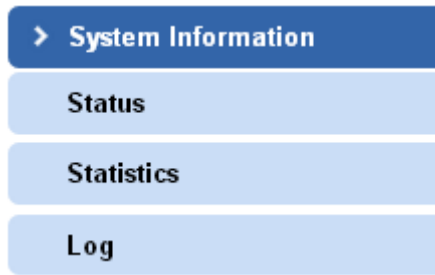

Figure 4-3-2: System Information Menu

4.3.1.1 Status

This section displays system information of Renewable Energy Switch as the screen in Figure 4-3-3 appears.

Table 4-3-1 describes the system information of the Renewable Energy Switch.

System Status	
System Information	
Firmware Version	v3.253b220128
Operating Mode	Bridge
System Temperature	38°C / 100°F
System Time	2022/2/11 17:6:18
Device Description	PLANET, BSP-360, Renewable Energy Managed PoE+ Switch/Router
Network Information	
Attain IP Protocol	Fixed IP
IP Address	192.168.1.233
Subnet Mask	255.255.255.0
Default Gateway	192.168.1.254
DHCP Server	Disabled
MAC Address	a8:f7:e0:79:c9:4d
Power Information	
Charge Board Firmware Version	v2.0b220210
Battery Type	Lithium
Battery Capacity	0Ah
Install Time of Battery	2022/2/7
Battery Life	365
PV In	23.26V / 0mA / 0.00W
Power Information	24.24V / 522.07mA / 12.65W
Battery In	24.24V / 0mA / 0W
Battery Capacity Status	82.50 %
<input type="checkbox"/> Auto Refresh Refresh Apply Reset	

Figure 4-3-3: System Information Web Page Screen

Object	Description
System Information	
Firmware Version	Displays the current firmware version of Renewable Energy Switch.
Operation Mode	Displays the current operation mode.
System Temperature	Displays the current system temperature of Renewable Energy Switch.
System Time	Displays the current system date of Renewable Energy Switch. The system date will be correct if NTP function is enabled and the Hub is connected to Internet.
Device Description	Displays the current device description and can be configured for user definition.
Network Information	
Attain IP Protocol	Displays the currently attained IP protocol of Renewable Energy Switch.
IP Address	Displays the current IP address of Renewable Energy Switch.
Subnet Mask	Displays the current subnet mask address of Renewable Energy Switch.
Default Gateway	Displays the current gateway address of Renewable Energy Switch.
DHCP Server	IP address of DHCP Server.
MAC Address	Displays the MAC address of Renewable Energy Switch.
Power Information	
Charge Board Firmware Version	Displays the current Charge Board firmware version of Renewable Energy Switch.
Battery Type	Lead-acid battery or Lithium battery.
Battery Capacity	Displays the capacity of battery.
Install Time of Battery	Displays the install time of battery. Go to the Battery management to enter the install time.
Battery Life	Displays the life of battery. Go to the Battery management to enter the life.
PV In	Displays the voltage, current and watt of PV in.
Power Information	Displays the voltage, current and watt of the system.
Battery In	Displays the voltage, current and watt of battery in.
Battery Capacity Status (%)	Displays the status of battery.

Table 4-3-1: Descriptions of the System Information Objects

4.3.1.2 Statistics

This section displays statistics information of battery capacity and PoE consumption as the screen in [Figure 4-3-4](#) appears. [Table 4-3-2](#) describes the system information of the Renewable Energy Switch.

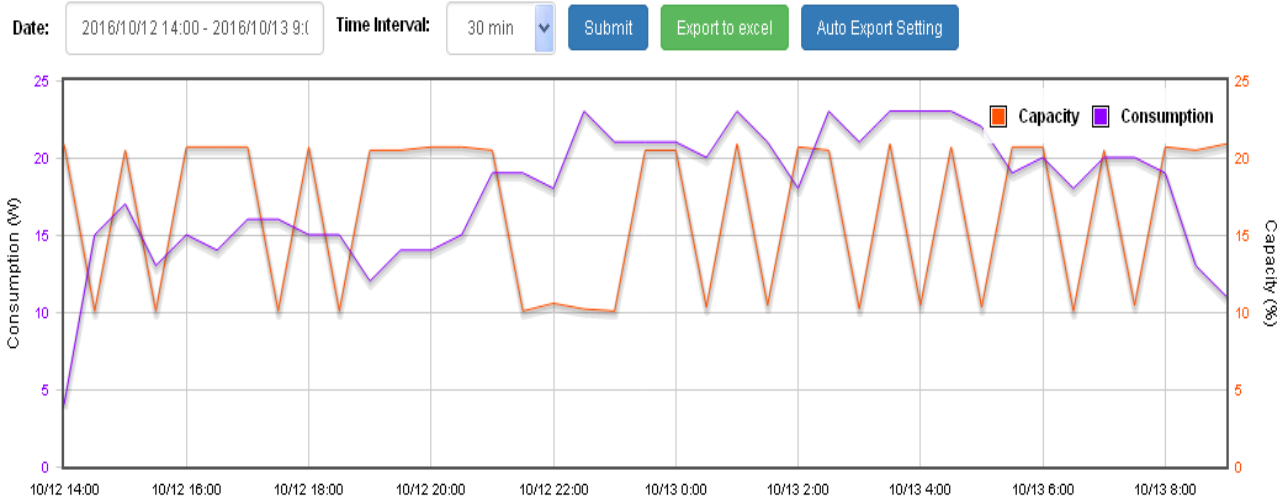



Figure 4-3-4: Statistics Web Page Screen

Object	Description
Consumption	Displays PoE consumption usage per hour.
Capacity	Displays battery capacity per hour.
Date	Select the date to see the battery capacity and PoE consumption per day.
Time Interval	Select 30 min. or 60 min.
Export to excel	Download this data chart excel to PC.
Auto Export Setting	Download this data chart to FTP server.

Table 4-3-2: Descriptions of the Statistics Objects



The statistics will recount after reboot.

4.3.1.3 Log

This section provides the system log setting and information display of Renewable Energy Switch as the screen in Figure 4-3-5 appears. Table 4-3-3 describes the system log setting object of Renewable Energy Switch.

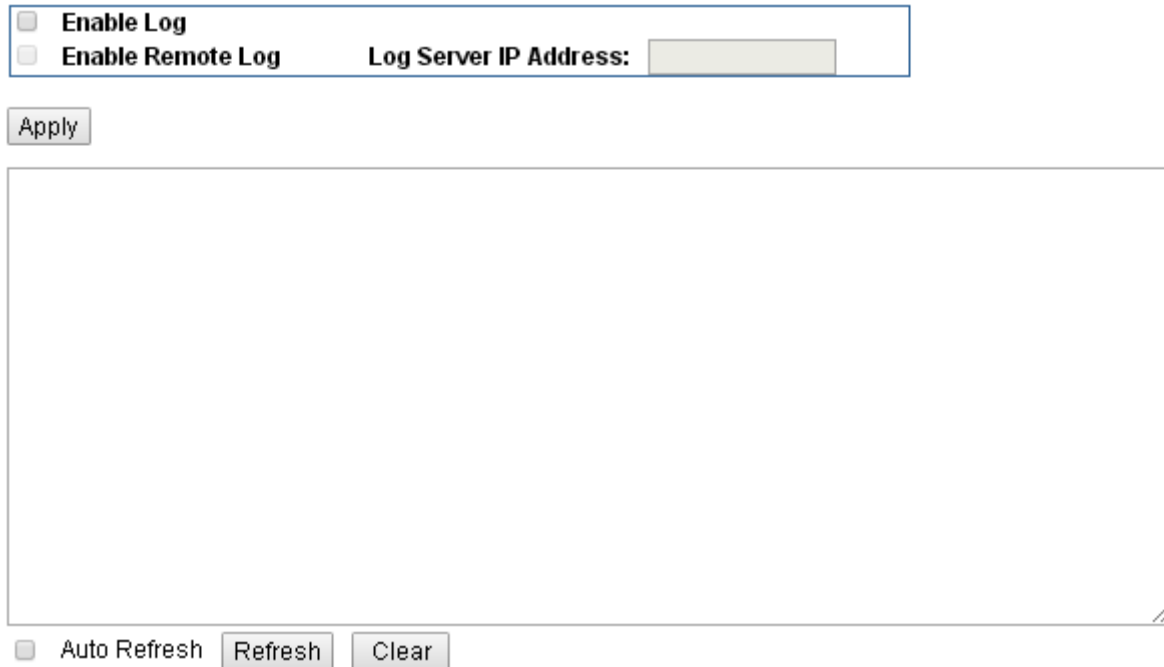

Figure 4-3-5: System Log Web Page Screen

Object	Description
Enable Log	Disable or enable the system log function of Renewable Energy Switch.
Enable Remote Log	Allow to send system log to remote log server.
Log Server IP Address	Allow to set IP address of remote log server.
Apply	Press this button to take effect.
Auto-Refresh <input type="checkbox"/>	Check this box to refresh the page automatically. Automatic refresh occurs every 3 seconds.
Refresh	Press this button to refresh current Web page.
Clear	Press this button to clear system log information.

Table 4-3-3: Descriptions of the System Log Objects

4.3.2 Operation Mode

This section provides the current operation mode, and users can set different modes to LAN and WLAN interface for NAT and bridging function on Renewable Energy Switch as the screen in [Figure 4-3-6](#) appears.

[Table 4-3-4](#) describes the Operation Mode of Renewable Energy Switch.

Gateway : In this mode, the device is supposed to connect to internet via ADSL/Cable Modem. The NAT is enabled and PCs in LAN ports share the same IP to ISP through WAN port. The connection type can be setup in WAN page by using PPPOE, DHCP client, PPTP client , L2TP client or static IP.

Bridge : In this mode, all ethernet ports and wireless interface are bridged together and NAT function is disabled. All the WAN related function and firewall are not supported.

Figure 4-3-6: Operation Mode Web Page Screen

Object	Description
Gateway	In this mode, the device enables multiusers to share Internet via ADSL/Cable Modem. The wireless port shares the same IP to ISP through Ethernet WAN port. The wireless port acts the same as a LAN port while in the AP router mode.
Bridge	In this mode, the device can be used to combine multiple local networks together with the same device via wireless connection, especially for a home or office where separate networks can't be connected easily together with a cable.

Table 4-3-4: Descriptions of the IP Configuration Objects

4.3.3 Time Zone

This section assists you in setting the Renewable Energy Switch's system time. You can either select to set the time and date manually or automatically obtain the GMT time from Internet as the screen in [Figure 4-3-7](#) appears and [Table 4-3-5](#) describes the NTP Configuration object of Renewable Energy Switch.

Current Time : Yr Mon Day Hr Mn Sec

Time Zone Select :

Enable NTP client update

Automatically Adjust Daylight Saving

NTP server :

 (Manual IP Setting)

Figure 4-3-7: Time Zone Configuration Web Page Screen

Object	Description
Current Time	Allow input current time information of Renewable Energy Switch.
Copy Computer Time	Click "Copy Computer Time" to enter the required values automatically according to your computer's current time and date.
Time Zone Select	Allow to select the time zone according to the current location of Renewable Energy Switch.
Enable NTP Client Update	Allow to disable or enable time update from NTP server of Renewable Energy Switch.
NTP Server	Allow to choose one listed NTP server or assign one NTP server IP address manually for Renewable Energy Switch.
Apply	Press this button to take effect.
Reset	Press this button to revert to previously saved values.
Refresh	Press this button to refresh the current Web page.

Table 4-3-5: Descriptions of the Time Zone Configuration Objects

4.3.4 Geolocation

This section provides the settings of the latitude, longitude, and altitude of Renewable Energy Switch as the screen in [Figure 4-3-8](#) appears. [Table 4-3-6](#) describes the Password Setting objects of Renewable Energy Switch.

Geolocation

You can manual key in the geolocation.

Latitude : Location:23.440, 120.85

Longitude : Altitude:200 m



Altitude : m 

Figure 4-3-8: Geolocation Setting Web Page Screen

Object	Description
Latitude	Allows to input the current latitude of Renewable Energy Switch.
Longitude	Allows to input the current longitude of Renewable Energy Switch.
Altitude	Allows to input the current altitude of Renewable Energy Switch.

Table 4-3-6: Setting the Geolocation of the Device



1. For security reason, please change and memorize the new password after this first setup.

2. The maximum length is 32 characters.

4.3.5 User Management

This section provides the Password Setting of Renewable Energy Switch as the screen in [Figure 4-3-9](#) appears. [Table 4-3-7](#) describes the Password Setting objects of Renewable Energy Switch.

Password Setting

User Name	admin
Old Password	
New Password	
Confirmed Password	

Figure 4-3-9 Password Setting Web Page Screen

Object	Description
User Name	Allows to input the current User Name of Renewable Energy Switch.
Old Password	Allows to input the current Password of Renewable Energy Switch.
New Password	Allows to input new Password of Renewable Energy Switch.
Confirmed Password	Allows to input new Password again for confirmation of Renewable Energy Switch.
Apply	Press this button to take effect.
Reset	Press this button to reset password setting to default mode.

Table 4-3-7: Descriptions of the Password Setting Objects

 Note	<ol style="list-style-type: none"> 1. For security reason, please change and memorize the new password after this first setup. 2. The maximum length is 15 characters.
---	--

4.3.6 SNMP

This section provides SNMP setting of Renewable Energy Switch as the screen in [Figure 4-3-10](#) appears and [Table 4-3-8](#) describes the SNMP objects of Renewable Energy Switch.

SNMP Management

System Community	
SNMP Agent	Disable ▾
SNMP Read Community	public
SNMP Write Community	private
System Option	
System Name	BSP-360
System Location	Default Location
Contact	Default Contact
SNMP Trap Receiver Configuration	
SNMP Trap	Disable ▾
SNMP Trap Destination	192.168.0.200

Figure 4-3-10: SNMP Web Page Screen

Object	Description
SNMP Agent	Disable or enable the SNMP Agent function of Renewable Energy Switch.
SNMP Read Community	Allow to input characters for SNMP Read Community of Renewable Energy Switch. The maximum length is 30 characters.
SNMP Write Community	Allows to input characters for SNMP Write Community of Renewable Energy Switch. The maximum length is 30 characters.
System Name	Allows to input characters for System Name of Renewable Energy Switch. The maximum length is 30 characters.
System Location	Allows to input characters for System Location of Renewable Energy Switch. The maximum length is 30 characters.
Contact	Allows to input characters for contact of Renewable Energy Switch. The maximum length is 30 characters.
SNMP Trap	Allows to enable or disable SNMP Trap function.
SNMP Trap Destination	Allows to send SNMP trap to an assigned workstation.

Table 4-3-8: Descriptions of the SNMP Objects

4.3.7 Remote Management

This section provides remote management setting of Renewable Energy Switch using NMS-360 series as the screen in [Figure 4-3-11](#) appears and [Table 4-3-9](#) describes the SNMP objects of Renewable Energy Switch.

Remote NMS Configuration

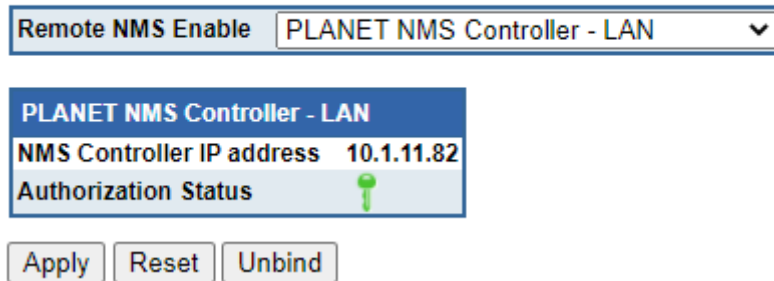

Figure 4-3-11: Remote Management Web Page Screen





Object	Description
Remote NMS Enable	Disable or enable the NMS Client function of Renewable Energy Switch.
NMS Controller IP address	Displays the current NMS-360 controller IP address.
Authorization Status	<ul style="list-style-type: none">  Can be managed  Already been managed  Disable NMS management function  Failed to manage with NMS-360 controller
Apply	Press this button to save and apply the configuration.
Reset	Press this button to revert to previously saved values.
Unbind	Press this button to manually bind with NMS-360 controller.

Table 4-3-9: Descriptions of the Remote Management Objects

4.4 TCP/IP

The TCP/IP function provides WAN, LAN and network configurations of Renewable Energy Switch as [Figure 4-4-1](#) is shown below:

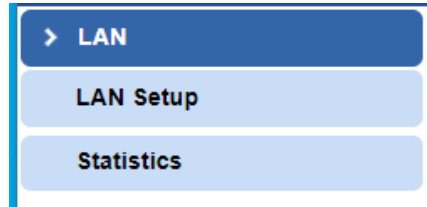

Figure 4-4-1: TCP/IP Function Menu

The page includes the following information:

Object	Description
LAN	Allow to set LAN interface. Explained in section 4.4.1.
Server	Allow to set Port Forwarding and DMZ. Explained in section 4.4.3.
Security	Allow to set firewall and access filtering. Explained in section 4.4.4.
Route	Allow to set Route interface. Explained in section 4.4.5.
QoS	Allow to set QoS (Quality of Service). Explained in section 4.4.6.

Table 4-4-1: WAN Interface Menu

4.4.1 LAN

You can configure LAN connection type manually here and see the LAN Statistics here as [Figure 4-4-2](#) is shown below:



Figure 4-4-2: LAN Interface Menu

4.4.1.1 LAN Setup

This page is used to configure the parameters for local area network which connects to the LAN port of your Access Point as the screen in [Figure 4-4-3](#) appears. [Table 4-4-2](#) describes the LAN Objects Screen of Renewable Energy Switch. Here you may change the setting for IP address, subnet mask, DHCP, etc.

IP Address :	<input type="text" value="192.168.0.100"/>
Subnet Mask :	<input type="text" value="255.255.255.0"/>
Default Gateway :	<input type="text" value="192.168.0.254"/>
DHCP :	<input type="text" value="Disabled"/>
DHCP Client Range :	<input type="text" value="192.168.0.101"/> - <input type="text" value="192.168.0.200"/> <input type="button" value="Show Client"/>
DHCP Lease Time :	<input type="text" value="480"/> (1 ~ 10080 minutes)
Static DHCP :	<input type="button" value="Set Static DHCP"/>
Domain Name :	<input type="text" value="Planet"/>
802.1d Spanning Tree :	<input type="text" value="Disabled"/>

Figure 4-4-3: LAN Interface Setup Web Page Screen

Object	Description
IP Address	The LAN IP address of the Renewable Energy Switch and default is 192.168.0.100 . You can change it according to your request.
Subnet Mask	Default is 255.255.255.0 . You can change it according to your request.
Default Gateway	Default is 192.168.0.254 . You can change it according to your request.
DHCP	You can select one of them -- Disable , Client , or Server . Default is Server -- the Renewable Energy Switch can assign IP addresses to the computers automatically.
DHCP Client Range	For the Server mode, you must enter the DHCP client IP address range in the field. And you can click the " Show Client " button to show the Active DHCP Client Table.
Domain Name	Default is Planet.
802.1d Spanning Tree	You can enable or disable the spanning tree function.

Table 4-4-2: Descriptions of the DDNS Objects

 Note	If you change the device's LAN IP address, you must enter the new one in your browser to get back to the web-based configuration utility. And LAN PCs' gateway must be set to this new IP for successful Internet connection.
---	---

4.4.1.2 Statistics

This page shows the packet counters for transmission and reception regarding Ethernet network as the screen in [Figure 4-4-4](#) appears. [Table 4-4-3](#) describes the Statistics Objects Screen of Renewable Energy Switch.

Interface	Receive	Transmit
Port 1	457.28 KBytes	1.32 MBytes
Port 2	0 Bytes	0 Bytes
Port 3	0 Bytes	0 Bytes
Port 4	457.28 KBytes	1.32 MBytes
Port 5	0 Bytes	0 Bytes

Refresh

Figure 4-4-4: Statistics Web Page Screen

Object	Description
Transmit	It shows the statistic count of sent packets on the Ethernet LAN interface.
Receive	It shows the statistic count of received packets on the Ethernet LAN interface.
Refresh	Click refresh to refresh the statistic counters on the screen.

Table 4-4-3: Descriptions of the Statistics Objects

4.5 Battery Management

The page provides the user to configure the battery parameters so as to achieve the best application condition as the screen in [Figure 4-5-1](#) appears. [Table 4-5-1](#) describes the Battery Management Objects Screen of Renewable Energy Switch. Before the configuration operation, please contact the suppliers of your battery for the product-specific parameters.

Battery Management

Battery Type	Lead-acid Battery ▾		
Battery Capacity	0	Ah	
Install Time of Battery	2022	1	12 Today
Battery Life	365	Days	
Fully-Charged Hold Time	60	Minute(s) (0~255) ⓘ	
Float Charge Voltage	27.2	V (26.0~30.0V)	
Absorption Charge Voltage	29.2	V (28.0~32.0V)	
Low Voltage Disconnection	22.2	V (21.0~23.0V)	
Low Voltage Reconnection	23.5	V (23.5~27.0V)	
Low Voltage Cut-off Protection Mode	OFF ▾		

Figure 4-5-1 Battery Management Web Page Screen

Object	Description
Battery Type	Lithium or Lead-acid battery.
Battery Capacity	Enter the Battery Capacity to the item. Please ask the battery vendor about this information.
Install Time of Battery	Enter the install time of battery to the item.
Battery Life	Enter the battery life to the item. Please ask the battery vendor about this information.
Fully-Charged Hold Time	When the battery is Fully-Charged, the controller will stop charging for a while.
Float Charge Voltage	DC 27.2V (26.0~30.0V) When the battery charge completes the charging process, its voltage will drop to a float charge voltage and maintain at this voltage with a minimal charging current for supplemental battery charging.
Absorption Charge Voltage	DC 29.2V (28.0~32.0V) When the battery voltage achieves the value of absorption charge voltage, the controller will maintain this voltage and charge for a period of time which will not cause excessive charging of the battery.
Low Voltage Disconnection	DC 22.2V (21.0~23.0V) When the battery voltage is less than the value for low-voltage

Object	Description
	disconnection, the controller will not supply to the load so as to protect the battery from overly discharge.
Low Voltage Reconnection	DC 23.5V (23.5~27.0V) If the battery voltage is recovered and higher than the value for low voltage reconnection, the low-voltage circuit disconnection will be lifted and the connection is restored.
Low Voltage Cut-Off Protection	Off Disable this function.
	Log & Trap When the battery capacity is lower than 20%, log and SNMP trap will be sent to server.
	Log, Trap & Cut When the battery capacity is lower than 20%, log and SNMP trap will be sent to server, and power to the low priority port will be shut off.
Reset	Press this button to revert to previously saved values.
Apply	Press this button to take effect.
Set Energy System to Default	Press this button to reset FCV, ACV, LVD and LVR settings to default values.
Reboot Energy System	Press this button to reboot the energy system board.

Table 4-5-1: Descriptions of the Battery Management Objects

Low Voltage Disconnection / Low Voltage Reconnection

When the battery voltage is lower than the value for the low-voltage disconnection (LVD), the controller will stop supplying power to the load. It requires the charging from the PV panel so as to increase the battery voltage to be above the value for low-voltage reconnection (LVR) and thus the PoE device can be recovered as the screen in [Figure 4-5-2](#) appears.

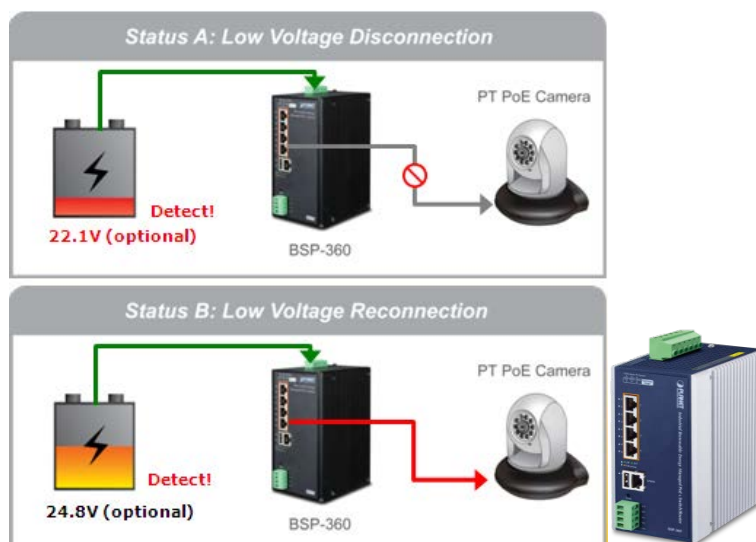

Figure 4-5-2 Low Voltage Disconnection / Low Voltage Reconnection

Low Voltage Cut-Off Protection

If the power is too low to empower the system and IP devices, the system will automatically power off the device with low priority to make sure the system works normally, and an alert is then sent to the administrator at the same time as the screen in [Figure 4-5-3](#) appears.

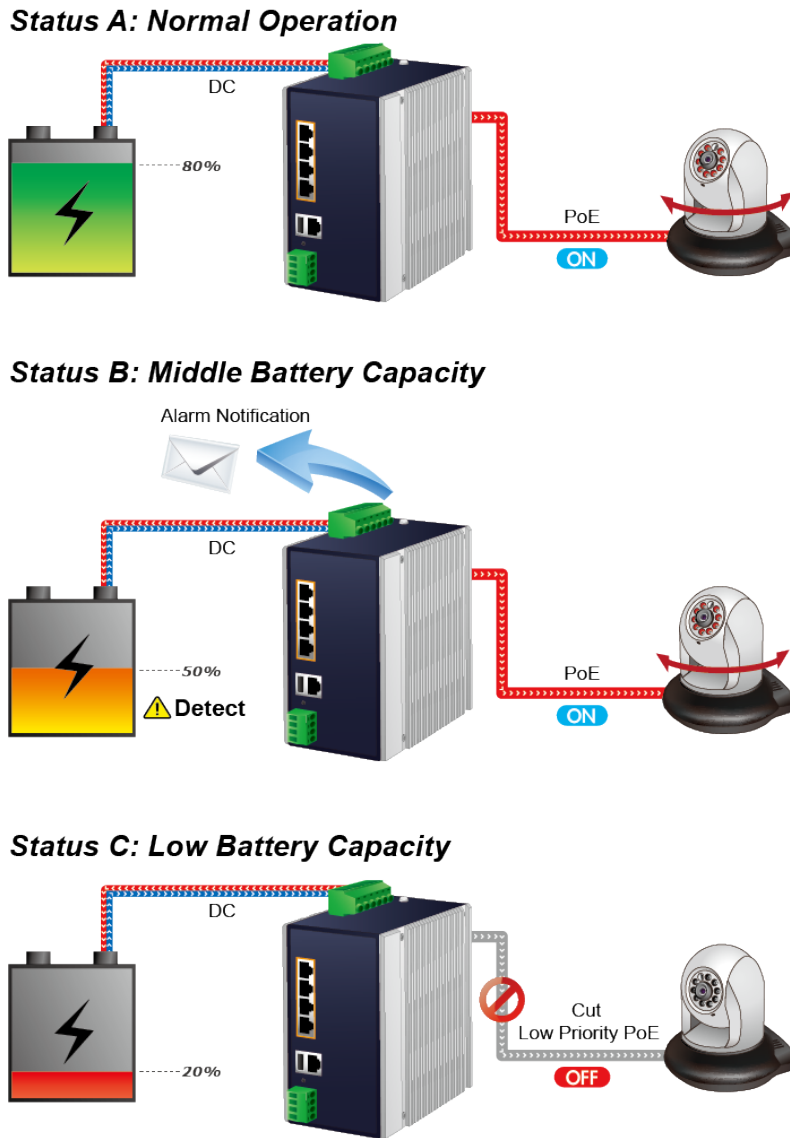

Figure 4-5-3 Low Voltage Cut-Off Protection

4.6 PoE Management

The PSU input power consumption is monitored by measuring voltage and current. The input power consumption is equal to the system's aggregated power consumption. The power management concept allows all ports to be active and activates additional ports, as long as the aggregated power of the system is lower than the power level at which additional PDs cannot be connected. When this value is exceeded, ports will be deactivated, according to user-defined priorities. The power budget is managed according to the following user-definable parameters: maximum available power, ports priority and maximum allowable power per port.

The Power over Ethernet provides PoE Configuration and PoE Schedule as shown in [Figure 4-6-1](#).

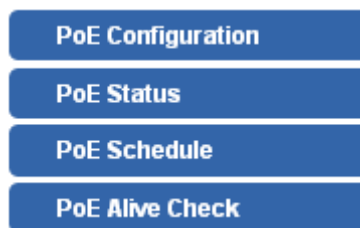

Figure 4-6-1: Power over Ethernet Function Menu

The page includes the following information:

Object	Description
PoE Configuration	Allow to centralize management PoE power for PDs. Explained in section 4.6.1.
PoE Status	Display the current PoE usage. Explained in section 4.6.2.
PoE Schedule	Allow to centralize management PoE power for providing schedule. Explained in section 4.6.3.
PD Alive Check	Allow to centralize management PoE power for checking PDs alive. Explained in section 4.6.4.

4.6.1 PoE Configuration

This section provides PoE (Power over Ethernet) Configuration and PoE output status of Renewable Energy Switch as screen in Figure 4-6-2 appears. Table 4-6-1 describes the PoE Configuration objects of Renewable Energy Switch.

PoE Configuration

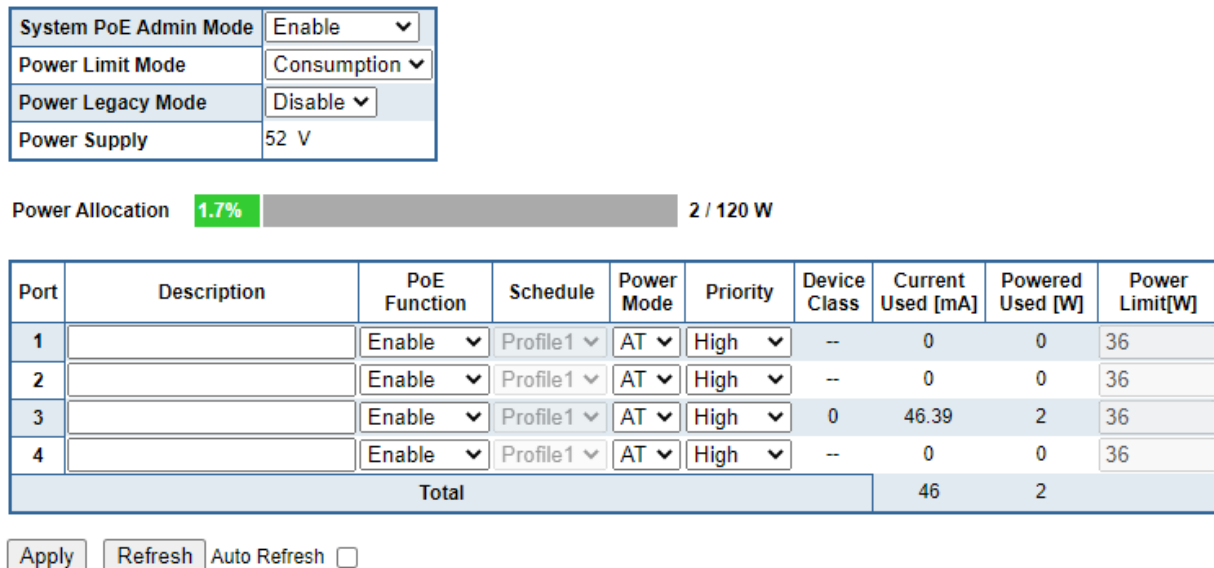

Figure 4-6-2: PoE Configuration Web Page Screen

Object	Description
System PoE Admin Mode	Allows user to disable / enable PoE function.
Power Limit Mode	Allows user to configure power limit mode, which can be chosen. Consumption: Based on the real device power consumption where PoE power is delivered as system default setting is in this mode. Allocation: Users are allowed to assign how much PoE power to each port and the system will reserve PoE power to PD.
Power Legacy Mode	Allows user to configure power legacy mode for PoE output
Power Supply	Displays PoE power supply status.
Power Allocation	Displays the current total power consumption status.
Description	This function provides input per port description and the available letters are 30. NOTE: The total maximum letters are only 800. Punctuations and others will be counted as 5 per word, like ‘, “, \, < and >.
PoE Function	Allows user to disable or enable per port PoE function, and also allows users to choose schedule by enabling PoE Schedule function of each port.
Schedule	Indicates the scheduled profile mode. Possible profiles are:

Object	Description
	<p>Profile1</p> <p>Profile2</p> <p>Profile3</p> <p>Profile4</p> <p>This function is available when choosing schedule on each port.</p>
Power Mode	<p>Allows user to select AT/AF compatibility mode. The default value is AT mode.</p> <p>Indicates the power inline mode.</p>
Priority	<p>The Priority represents PoE ports priority. There are three levels of power priority named Low, High and Critical.</p> <p>The priority is used in case the total power consumption is over the total power budget. In this case the port with the lowest priority will be turned off, and power is provided to the port of higher priority.</p>
Device Class	<p>Displays PoE class level.</p> <p>The IEEE 802.3af standard offers PoE class level from 1 to 3 and IEEE 802.3at standard offers the class from 1 to 4.</p>
Current Used [mA]	<p>The Power Used shows how much current the PD currently is using.</p>
Power Used [W]	<p>The Power Used shows how much power the PD currently is using</p>
Power Limit [W]	<p>It can limit the port PoE supply watts. Per port maximum value must be less than 36 watts. Total port values must be less than the Power Reservation value. Once power overload is detected, the port will auto shut down and keep in detection mode until PD's power consumption is lower than the power limit value.</p>
Apply	<p>Press this button to take effect.</p>
Refresh	<p>Press this button to refresh the current Web page.</p>
Auto-Refresh <input type="checkbox"/>	<p>Check this box to refresh the page automatically. Automatic refresh occurs every 3 seconds.</p>

Table 4-6-1: Descriptions of the PoE Configuration Objects

4.6.2 PoE Status

This page allows user to see the usage of individual PoE Port as the screen in [Figure 4-6-3](#) appears. [Table 4-6-2](#) describes the PoE Status Objects Screen of Renewable Energy Switch.

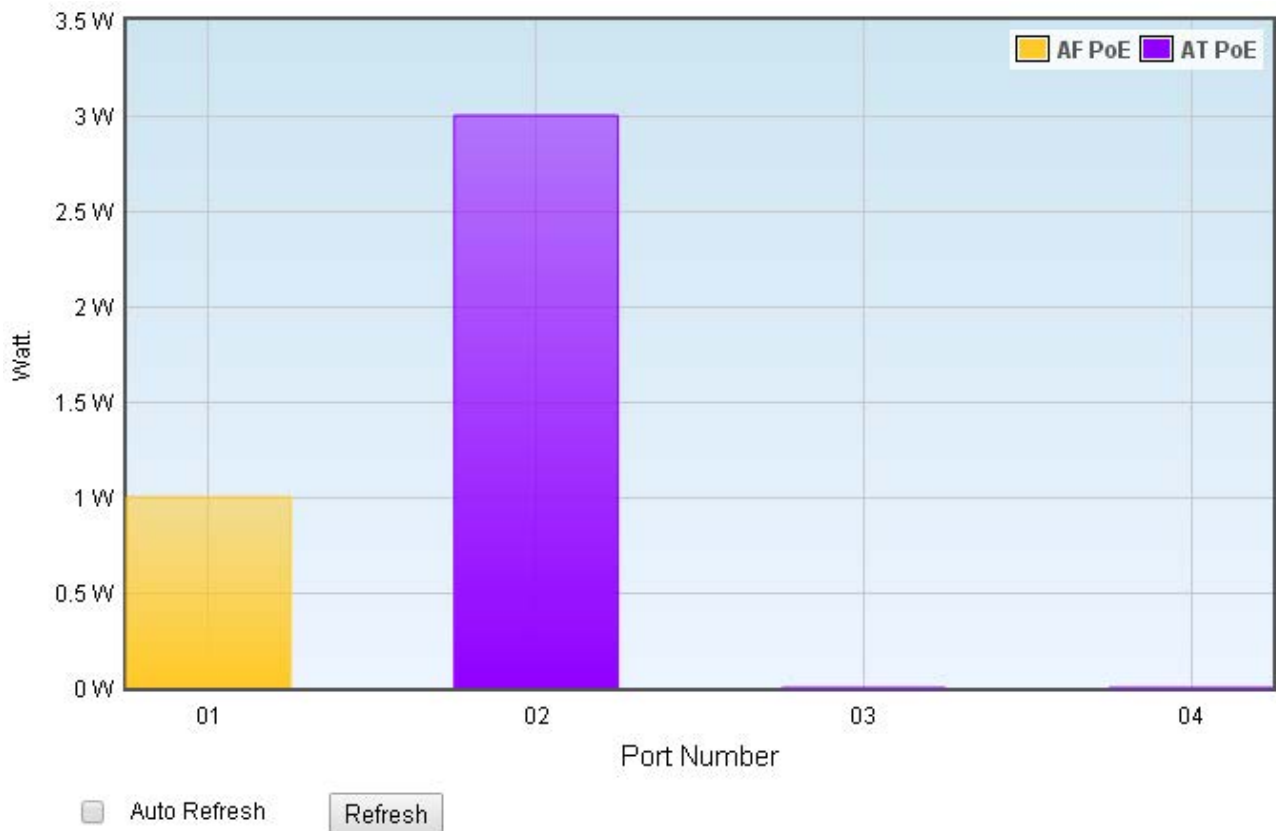

Figure 4-6-3: PoE Status Web Page Screen



Object	Description
Port Number	Displays per port status.
Watt	Displays per port PoE usage.
 AF PoE	Indicates the AF PoE operation mode of that port.
 AT PoE	Indicates the AT PoE operation mode of that port.
Refresh	Press this button to refresh the current Web page.
Auto Refresh	Check this box to refresh the page automatically. Automatic refresh occurs every 3 seconds.

Table 4-6-2: Descriptions of the PoE Status Objects

4.6.3 PoE Schedule

This section provides user with the configurations of PoE schedule and scheduled power recycling. The “**PoE schedule**” helps you to enable or disable PoE power feeding for PoE ports during specified time intervals and it is a powerful function to help SMBs or enterprises save power and money.

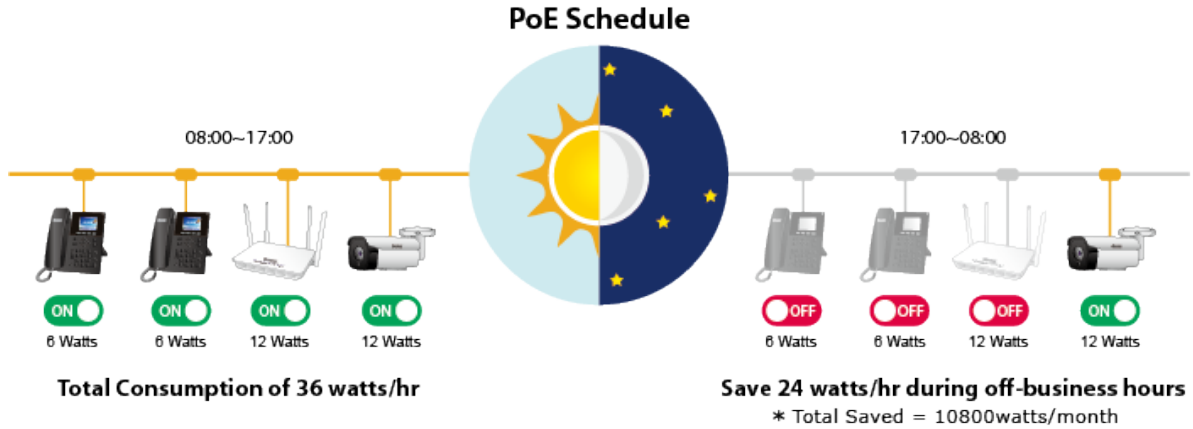

Scheduled Power Recycling

The Ultra PoE Managed Injector Hub allows each of the connected PoE IP cameras to reboot at a specified time each week. Therefore, it will reduce the chance of IP camera crash resulting from buffer overflow.

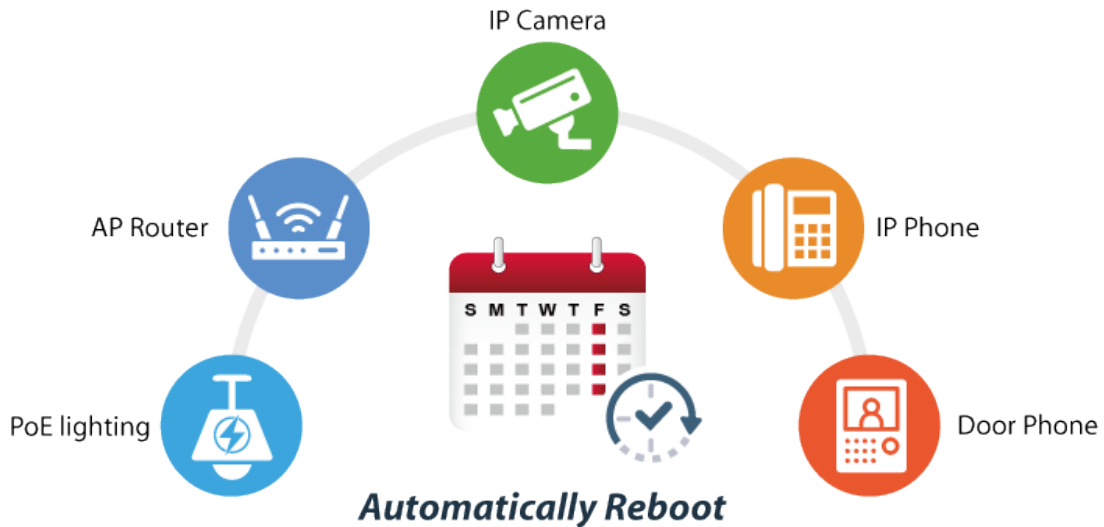

The PoE Schedule Profile Web Screens are shown in [Figure 4-6-4](#) and [Table 4-6-3](#).

Port	Description	PoE Function	Schedule	Power Mode	Priority	Device Class	Current Used [mA]	Powered Used [W]	Power Limit[W]
1		Schedule ▾	Profile1 ▾	AF ▾	High ▾	0	3.78	1	36
2		Schedule ▾	Profile2 ▾	AT ▾	High ▾	0	25.51	1	36
3		Schedule ▾	Profile3 ▾	AT ▾	High ▾	--	0	0	36
4		Schedule ▾	Profile4 ▾	AT ▾	High ▾	--	0	0	36
Total							29	2	

Figure 4-6-4: PoE Configuration Web Page Screen

Object	Description
PoE Function	Allows user to disable or enable per port PoE function, and also allows user to choose schedule by enabling PoE Schedule function of each port.
Schedule	Indicates the scheduled profile mode. Possible profiles are: Profile1 Profile2 Profile3 Profile4 This function available when choosing schedule on each port.
<input type="button" value="Apply"/> button	Saves the current configuration.
<input type="button" value="Refresh"/> button	Refreshes the Web page and the current configuration if user doesn't save it.
Auto-Refresh <input type="checkbox"/>	Check this box to refresh the page automatically. Automatic refresh occurs every 3 seconds.

Table 4-6-3: Descriptions of the per Port PoE Schedule Profile Objects

PoE Schedule user can configure a duration time for PoE port as default value does not provide power; screen in [Figure 4-6-5](#) and [Table 4-6-4](#) show.

Profile

Delete	Week Day	Start Hour	Start Min	End Hour	End Min	Reboot Enable	Reboot Only	Reboot Hour	Reboot Min
Delete	Sun. ▾	0 ▾	0 ▾	23 ▾	59 ▾	<input type="checkbox"/>	<input type="checkbox"/>	0 ▾	0 ▾

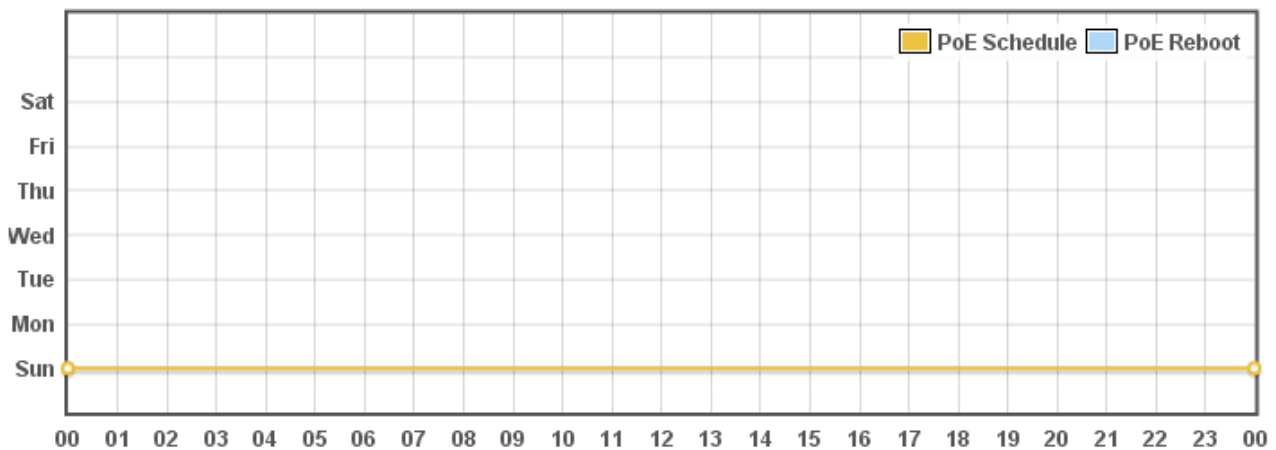

Figure 4-6-5: PoE Schedule Web Page Screen



Object	Description
Profile	Set the schedule profile mode. Possible profiles are: Profile1 Profile2 Profile3 Profile4
Delete	Check to delete the entry.
Week Day	Allows user to set week day for defining PoE function by enabling it on the day. Sun.: Sunday Mon.: Monday Tue.: Tuesday Wed.: Wednesday Thu.: Thursday Fri.: Friday Sat.: Saturday
Start Hour	Allows user to set what hour PoE function does by enabling it.
Start Min	Allows user to set what minute PoE function does by enabling it.
End Hour	Allows user to set what hour PoE function does by disabling it.
End Min	Allows user to set what minute PoE function does by disabling it.
Reboot Enable	Allows user to enable or disable the whole PoE port reboot by PoE reboot schedule. Please note that if you want PoE schedule and PoE reboot schedule to work at the same time, please use this function, and don't use Reboot Only function. This function offers administrator to reboot PoE device at an indicated time if administrator has this kind of requirement.
Reboot Only	Allows user to reboot PoE function by PoE reboot schedule. Please note that if administrator enables this function, PoE schedule will not set time to profile. This function is just for PoE port to reset at an indicated time.
Reboot Hour	Allows user to set what hour PoE reboots. This function is only for PoE reboot schedule.
 button	Click to add new rule.
 button	Click to apply changes.
 button	Check to delete the entry.

Table 4-6-4: Descriptions of the PoE Schedule Configuration Objects

4.6.4 PoE Alive Check Configuration

The Renewable Energy Switch can be configured to monitor connected PD's status in real-time via ping action. Once the PD stops working and responding, the Renewable Energy Switch are going to restart PoE port power, and bring the PD back to work. It will greatly enhance the reliability and reduces administrator management burden.

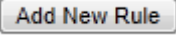
PD Alive Check

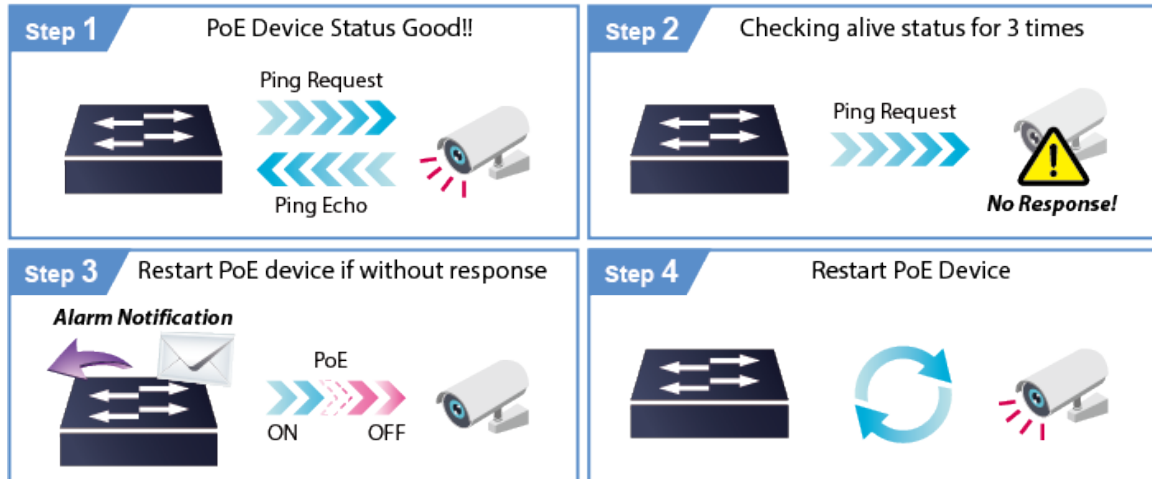

This page provides you with how to configure PD Alive Check as the screen in Figure 4-6-6 appears.

Port	Mode	Remote PD IP Address	Interval Time (10~300s)	Retry Count (1~5)	Action	Reboot Time (30~180s)
1	Disable ▼	192.168.0.101	60	2 ▼	None ▼	60
2	Disable ▼	192.168.0.101	60	2 ▼	None ▼	60
3	Disable ▼	192.168.0.101	60	2 ▼	None ▼	60
4	Disable ▼	192.168.0.101	60	2 ▼	None ▼	60

Apply Refresh

Figure 4-6-6: PD Alive Check Configuration Web Page Screen

Object	Description
Mode	Allows user to enable or disable per port PD Alive Check function. All ports are disabled as default value.
Remote PD IP Address	This column allows user to set PoE device IP address here for system making ping to the PoE device. Please note that the PD's IP address must be set to the same network segment as the Renewable Energy Switch.
Interval Time (10~300s)	This column allows user to set how long system should issue a ping request to PD for detecting whether PD is alive or dead. Interval time range is from 10 seconds to 300 seconds.
Retry Count (1~5)	This column allows user to set how many times system wants to retry ping to PD. For example, if we set to count 2, the system will retry ping to the PD for two times. If the PD doesn't response continuously, the PoE port will be reset.
Action	Allows user to set which action will be applied if the PD is without any response. The Renewable Energy Switch offers 3 actions as follows: PD Reboot: It means system will reset the PoE port that is connected to the PD. PD Reboot & Alarm: It means system will reset the PoE port and issue an alarm message via Syslog, Alarm: It means system will issue an alarm message via Syslog.
Reboot Time (30~180s)	This column allows user to set the PoE device rebooting time. As there are so many kinds of PoE devices on the market, they have different rebooting times. The PD Alive-check is not a defining standard, so the PoE device on the market doesn't report reboots done information to the Ultra PoE Managed Injector Hub. So user has to make sure how long the PD will be finished to boot, and then set the time value to this column. System is going to check the PD again according to the reboot time. If you cannot make sure precise booting time, we suggest you set it longer.
 button	Click to apply changes.
 button	Refreshes the Web page and the current configuration if user doesn't save it.

Table 4-6-5: Descriptions of the PoE Schedule Configuration Objects

4.7 ONVIF

PLANET has developed an awesome feature -- ONVIF Support -- which is specifically designed for co-operating with video IP surveillances. From the GUI, clients just need one click to search and show all of the ONVIF devices via network application. In addition, clients can upload floor images to the switch series, making the deployments of surveillance and other devices easy for planning and inspection purposes. Moreover, clients can get real-time surveillance's information and online/offline status; the PoE reboot can be controlled from the GUI.

The ONVIF function menu is shown in [Figure 4-6-1](#).

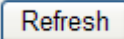

Figure 4-7-1:ONVIF Function Menu

The page includes the following information:

Object	Description
ONVIF Device Search	Allow to discover PLANET ONVIF IP camera and add to device management list. Explained in section 4.7.1
ONVIF Device List	Display the current BSP-360 ports 1-4 for PLANET ONVIF IP cameras. Explained in section 4.7.2

4.7.1 ONVIF Device Search

This section provides search and configuration of the ONVIF IP cam information of Renewable Energy Switch as screen in [Figure 4-7-2](#) appears and [Table 4-7-1](#) shows.

ONVIF Device Search

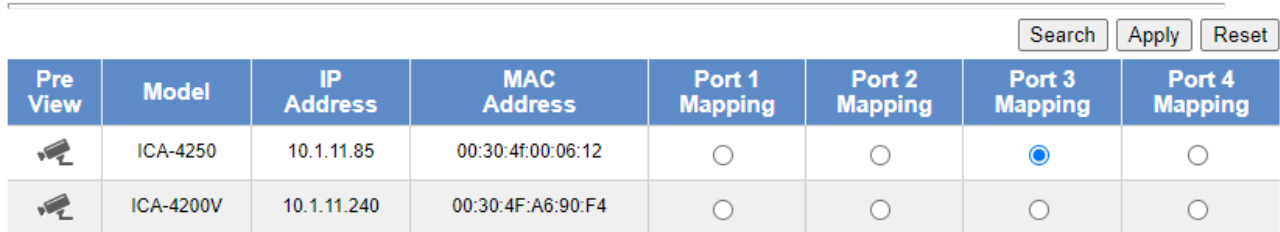



Pre View	Model	IP Address	MAC Address	Port 1 Mapping	Port 2 Mapping	Port 3 Mapping	Port 4 Mapping
	ICA-4250	10.1.11.85	00:30:4f:00:06:12	<input type="radio"/>	<input type="radio"/>	<input checked="" type="radio"/>	<input type="radio"/>
	ICA-4200V	10.1.11.240	00:30:4F:A6:90:F4	<input type="radio"/>	<input type="radio"/>	<input type="radio"/>	<input type="radio"/>

Figure 4-7-2: ONVIF IP Cam Configuration Web Page Screen

Object	Description
Preview	 Press icon to get current snapshot of PLANET ONVIF IP cam.
Mode	Show the IP cam model.
IP Address	Show the IP cam IP address.
MAC Address	Show the IP cam MAC address.
Ports 1-4 Mapping	Allow to select PLANET ONVIF IP camera and BSP-360 for port mapping by user define
Search	Press this button to discover all of the IP cams in the same sub-net.
Apply	Press this button to take effect.
Reset	Press this button to revert to previously saved values.

Table 4-7-1: Descriptions of the ONVIF Device Search Objects

4.7.2 ONVIF Device List

This section provides managed ONVIF IP cam information of Renewable Energy Switch as screen in [Figure 4-7-3](#) appears and [Table 4-7-2](#) shows.

ONVIF Device List





View	Status	Model	IP Address	MAC Address	Port 1 Mapping	Port 2 Mapping	Port 3 Mapping	Port 4 Mapping	Action
		ICA-4250	10.1.11.85	00:30:4f:00:06:12	<input type="radio"/>	<input type="radio"/>	<input checked="" type="radio"/>	<input type="radio"/>	  

Figure 4-7-3: ONVIF IP Cam Device List Web Page Screen





Object	Description
View	 Press icon to get current snapshot of PLANET ONVIF IP cam.
Status	Show the IP cam alive checking status, linkup(Green) or linkdown(Red).
Mode	Show the IP cam model.
IP Address	Show the IP cam IP address.
MAC Address	Show the IP cam MAC address.
Ports 1-4 Mapping	Allow to select PLANET ONVIF IP camera and BSP-360 for port mapping by user define
Hyperlink to IP cam Login page	 Press icon to go to current login page of PLANET ONVIF IP cam.
Reboot IP cam	 Press icon to reboot the PLANET ONVIF IP cam.
Delete IP cam form list	 Press icon to remove the PLANET ONVIF IP cam from managed list.
Refresh	Press this button to refresh this page.
Apply	Press this button to take effect.
Reset	Press this button to revert to previously saved values.

Table 4-7-2: Descriptions of the ONVIF Device List Objects

4.7.3 Preview – Snapshot

This section provides snapshot from ONVIF IP cam of Renewable Energy Switch as screen in [Figure 4-7-4](#) appears and [Table 4-7-3](#) shows.

View Snapshot ✕

Model	MAC Address	IP Address	Location	Description
ICA-4250	00:30:4f:00:06:12	10.1.11.85	city/SZ	PLANET

Username:

Password:

Figure 4-7-3: View Snapshot Web Page Screen

Object	Description
Mode	Show the IP cam model.
MAC Address	Show the IP cam MAC address.
IP Address	Show the IP cam IP address.
Location	Show the IP cam IP location information in ONVIF data.
Description	Show the IP cam IP description information in ONVIF data.
Username	For security, please enter the IP cam login username to do snapshot.
Password	For security, please enter the IP cam password to do snapshot.
Get Snapshot	Press this button to get snapshot from the IP cam in the same sub-net.
Save	Press this button to save the username and password.
Reset	Press this button to revert to previously saved values.

Table 4-7-3: Descriptions of the ONVIF Device List Objects

4.8 Maintenance

The page displays the following tabs relative to system configurations as [Figure 4-7-1](#) is shown below:

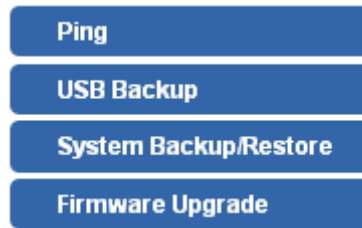

Figure 4-7-1: Maintenance Function Menu

The page includes the following information:

Object	Description
Ping	Allow you to issue ICMP PING packets to troubleshoot IP. Explained in section 4.7.1.
USB Backup	Backup and restore setting file via USB HDD. Explained in section 4.7.2.
System Backup/Restoration	Backup and restore setting file via PC. Explained in section 4.7.3.
Firmware	Firmware upgrade. Explained in section 4.7.4.

4.8.1 Ping

This page allows you to issue ICMP PING packets to troubleshoot IP connectivity issues.

After you press “**Ping**”, 5 ICMP packets are transmitted, and the sequence number and roundtrip time are displayed upon reception of a reply. The page refreshes automatically until responses to all packets are received, or until a timeout occurs. The ICMP Ping screen in [Figure 4-7-2](#) appears. [Table 4-7-1](#) describes the ICMP Ping Objects Screen of Renewable Energy Switch.

IP Address :
Counts :

Figure 4-7-2: ICMP Ping Web Page Screen



Object	Description
IP Address	The destination IP Address.
Counts	The time of ping.
 button	Press this button to refresh the current Web page.

Table 4-7-1: Descriptions of the ICMP Ping Configuration Objects

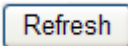

Note Be sure the target IP address is within the same network subnet of the Renewable Energy Switch, or you have to set up the correct gateway IP address.

4.8.2 USB Backup

This page shows the status of the USB HDD. You may save the setting file to USB HDD and load the setting file from USB HDD as the screen in [Figure 4-7-3](#) appears. [Table 4-7-2](#) describes the WAN Objects Screen of Renewable Energy Switch.

USB HDD : HDD Detected (Available Space: 7.881412GB)

Save Settings to USB HDD :

Load Settings from USB HDD :

Please format the HDD to FAT32 on a Windows PC before using it for backup

Figure 4-7-3: USB Backup Web Page Screen

Object	Description
USB HDD	The status of USB HDD.
Save Settings to USB HDD	Press <input type="button" value="Save"/> button to save setting file to USB HDD.
Load Settings from USB HDD	Press <input type="button" value="Upload"/> button to upload setting file from USB HDD.
 button	Press this button to refresh the current Web page.

Table 4-7-2: Descriptions of the USB Backup Configuration Objects

4.8.3 System Backup/Restoration

You may save the setting file to PC and load the setting file from PC as the screen in [Figure 4-7-4](#) appears. [Table 4-7-3](#) describes the System Backup/Restoration Objects Screen of Renewable Energy Switch.

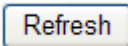
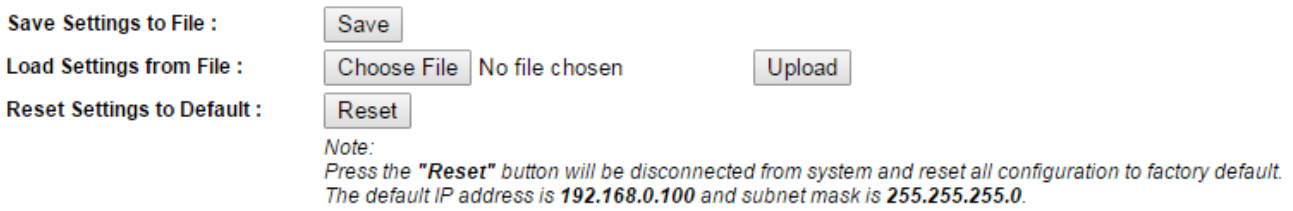

Figure 4-7-4: System Backup/Restoration Web Page Screen

Object	Description
Save Settings to File	Press <input type="button" value="Save"/> button to save setting file to PC.
Load Settings from File	Press <input type="button" value="Choose File"/> button to select the setting file, then press <input type="button" value="Upload"/> button to upload setting file from PC.
Reset Setting to Default	Press <input type="button" value="Reset"/> button to reset to factory default.

Table 4-7-3: Descriptions of the System Backup/Restoration Objects

4.8.4 Firmware Upgrade

This section provides the firmware upgrade of Renewable Energy Switch as the screen in [Figure 4-7-5](#) appears.

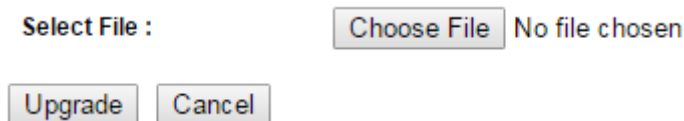

Figure 4-7-5: Firmware Upgrade Web Page Screen

Object	Description
<input type="button" value="Choose File"/> button	Press the button to select the firmware.
<input type="button" value="Upgrade"/> button	Press the button to upgrade firmware to system.

Table 4-7-4: Descriptions of the Firmware Upgrade Objects

5. POWER OVER ETHERNET OVERVIEW

What is PoE?

Based on the global standard IEEE 802.3af, PoE is a technology for wired Ethernet, the most widely installed local area network technology adopted today. PoE allows the electrical power necessary for the operation of each end-device to be carried by data cables rather than by separate power cords. New network applications, such as IP Cameras, VoIP Phones, and Wireless Networking, can help enterprises improve productivity. It minimizes wires that must be used to install the network for offering lower cost, and less power failures.

IEEE802.3af, also called Data Terminal equipment (DTE) power via Media dependent interface (MDI), is an international standard to define the transmission for power over Ethernet. The IEEE 802.3af also defines two types of source equipment: Mid-Span and End-Span.

■ Mid-Span

Mid-Span device is placed between legacy switch and the powered device. Mid-Span taps the unused wire pairs 4/5 and 7/8 to carry power; the other four are for data transmission

■ End-span

End-span device is directly connected with power device. End-span could also tap the wire 1/2 and 3/6.

■ PoE system architecture

The specification of PoE typically requires two devices: the Powered Source Equipment (PSE) and the Powered Device (PD). The PSE is either an End-span or a Mid-span, while the PD is a PoE-enabled terminal, such as IP Phones, Wireless LAN, etc. Power can be delivered over data pairs or spare pairs of standard CAT-5e cabling.

■ How power is transferred through the cable

A standard Cat5e Ethernet cable has four twisted pairs, but only two of these are used for 10BASE-T, 100BASE-TX and 1000BASE-T. The specification allows two options for using these cables for power as shown in [Figure 5-1-1](#) and [Figure 5-1-2](#).

The spare pairs are used. [Figure 5-1-1](#) shows the pair on pins 4 and 5 are connected together and form the positive supply, and the pair on pins 7 and 8 is connected and forms the negative supply. (In fact, a late change to the specification allows either polarity to be used.).

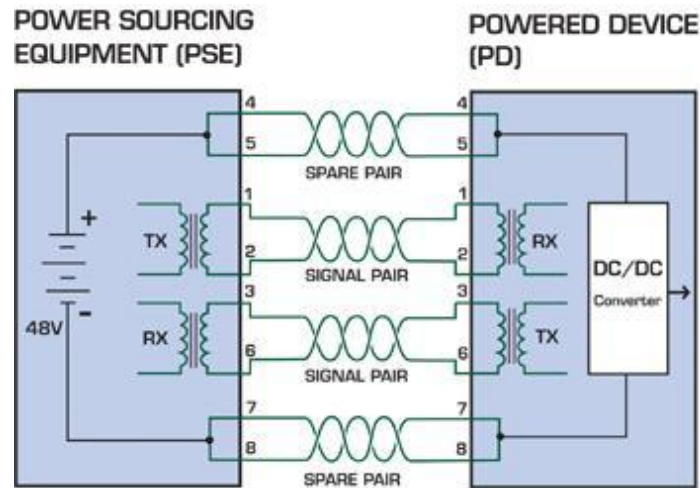

Figure 5-1-1 - Power Supplied over the Spare Pins

The data pairs are used. Since Ethernet pairs are transformer coupled at each end, it is possible to apply DC power to the center tap of the isolation transformer without upsetting the data transfer. In this mode of operation the pair on pins 3 and 6 and the pair on pins 1 and 2 can be of either polarity.

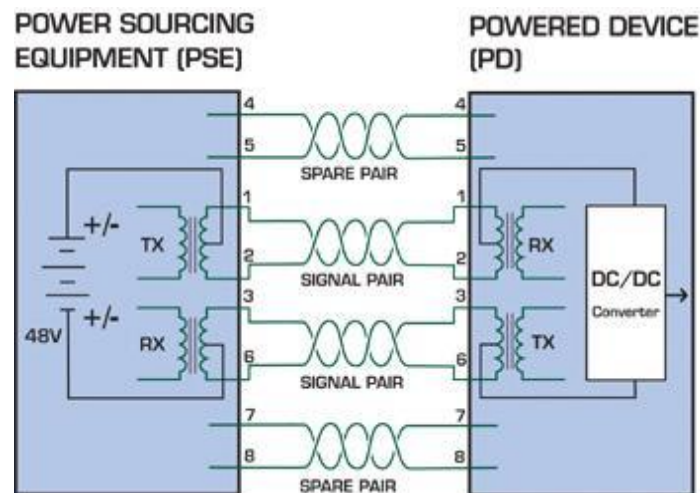

Figure 5-1-2 - Power Supplied over the Data Pins

When to install PoE

Consider the following scenarios:

- You're planning to install the latest VoIP Phone system to minimize cabling building costs when your company moves into a new office.
- The company staff has been clamoring for a wireless access point in the picnic area behind the building so they can work on their laptops through lunch, but the cost of electrical power to the outside is not affordable.
- Management asks for IP Surveillance Cameras and business access systems throughout the facility, but they would rather avoid another electrician's payment.

6. THE POE PROVISION PROCESS

While adding PoE support to networked devices is relatively painless, it should be realized that power cannot simply be transferred over existing Cat5e cables. Without proper preparation, doing so may result in damage to devices that are not designed to support provision of power over their network interfaces.

The PSE is the manager of the PoE process. At the beginning, only small voltage level is induced on the port's output till a valid PD is detected during the Detection period. The PSE may choose to perform classification to estimate the amount of power to be consumed by this PD. After a time-controlled start-up, the PSE begins supplying the 52V DC level to the PD till it is physically or electrically disconnected. Upon disconnection, voltage and power are shut down.

Since the PSE is responsible for the PoE process timing, it is the one generating the probing signals prior to operating the PD and monitoring the various scenarios that may occur during operation.

All probing is done using voltage induction and current measurement in return.

Stages of powering up a PoE link

Stage	Action	Volts specified		Volts managed by chipset
		802.3af	802.3at	
Detection	Measure whether powered device has the correct signature resistance of 15–33 kΩ	2.7-10.0		1.8–10.0
Classification	Measure which power level class the resistor indicates	14.5-20.5		12.5–25.5
Startup	Where the powered device will start up	>42	>37.2	>38
Normal operation	Supply power to device	44-57	50-57	25.0–60.0

6.1 Line Detection

Before power is applied, safety dictates that it must first be ensured that a valid PD is connected to the PSE's output. This process is referred to as "line detection", and involves the PSE seeking a specific, 25 KΩ signature resistor. Detection of this signature indicates that a valid PD is connected, and that provision of power to the device may commence.

The signature resistor lies in the PD's PoE front-end, isolated from the rest of the PD's circuitries till detection is certified.

6.2 Classification

Once a PD is detected, the PSE may optionally perform classification to determine the maximal power a PD is to consume. The PSE induces 15.5-25.5V DC, limited to 600 mA, for a period of 10 to 75 ms responded by a certain current consumption by the PD, indicating its power class.

The PD is assigned to one of 5 classes: 0 (default class) indicates that full 15.4 watts should be provided, 1-3 indicate various required power levels and 4 has a power range of 12.95 – 25.5 watts. PDs that support classification are assigned to class 0. Special care must be employed in the definition of class thresholds, as classification may be affected by cable losses.

Classifying a PD according to its power consumption may assist a PoE system in optimizing its power distribution. Such a system typically suffers from lack of power resources, so that efficient power management based on classification results may reduce total system costs.

6.3 Start-up

Once line detection and optional classification stages are completed, the PSE must switch from low voltage to its full voltage capacity (44-57 Volts) over a minimal amount of time (above 15 microseconds).

A gradual startup is required, as a sudden rise in voltage (reaching high frequencies) would introduce noise on the data lines.

Once provision of power is initiated, it is common for inrush current to be experienced at the PSE port, due to the PD's input capacitance. A PD must be designed to cease inrush current consumption (of over 350 mA / 600mA) within 50 ms of power provision startup.

6.4 Operation

During normal operation, the PSE provides 44-57 VDC, able to support a minimum of 15.4watt / 25.5-watt power.

Power Overloads

The IEEE 802.3af / IEEE 802.3at standard defines handling of overload conditions. In the event of an overload (a PD drawing a higher power level than the allowed 12.95 watts / 25.5 watts), or an outright short circuit caused by a failure in cabling or in the PD, the PSE must shut down power within 50 to 75 milliseconds, while limiting current drain during this period to protect the cabling infrastructure. Immediate voltage drop is avoided to prevent shutdown due to random fluctuations.

6.5 Power Disconnection Scenarios

The IEEE 802.3af / IEEE 802.3at standard requires that devices powered over Ethernet be disconnected safely (i.e. power needs to be shut down within a short period of time following disconnection of a PD from an active port).

When a PD is disconnected, there is a danger that it will be replaced by a non-PoE-ready device while power is still on. Imagine disconnecting a powered IP phone utilizing 52 VDC, and then inadvertently plugging the powered Ethernet cable into a non-PoE notebook computer. What's sure to follow is not a pretty picture.

The standard defines two means of disconnection, DC Disconnect and AC Disconnect, both of which provide the same functionality - the PSE shuts down power to a disconnected port within 300 to 400ms. The upper boundary is a physical human limit for disconnecting one PD and reconnecting another.

DC Disconnect

DC Disconnect detection involves measurement of current. Naturally, a disconnected PD stops consuming current, which can be inspected by the PSE. The PSE must therefore disconnect power within 300 to 400 ms from the current flow stop. The lower time boundary is important to prevent shutdown due to random fluctuations.

AC Disconnect

This method is based on the fact that when a valid PD is connected to a port, the AC impedance measured on its terminals is significantly lower than in the case of an open port (disconnected PD).

AC Disconnect detection involves the induction of low AC signal in addition to the 52 VDC operating voltage. The returned AC signal amplitude is monitored by the PSE at the port terminals. During normal operation, the PD's relatively low impedance lowers the returned AC signal while a sudden disconnection of this PD will cause a surge to the full AC signal level and will indicate PD disconnection.

APPENDIX A.

A.1 MDI Settings

The Medium-Dependent Interface (MDI or RJ45) serves as the data/power interface between Ethernet elements. As such, it has two optional connection methods to carry the power. Named Alternative A & B, Table 1 details the two power feeding alternatives.

Pin	Alternative A	Alternative B
1	Vport Negative	
2	Vport Negative	
3	Vport Positive	
4		Vport Positive
5		Vport Positive
6	Vport Positive	
7		Vport Negative
8		Vport Negative

Table -1 Alternative Table

Delivering power through an RJ45 connector's center tap ("Phantom Feeding") guarantees that bi-directional data flow is maintained, regardless of a module's power status.

A.2 Power Device Classification Values

Class	PD Current – Classification Period [mA]	PD Power – Operation Period [W]	Note
0	0 – 4	0.44 – 12.95	Default
1	9 – 12	0.44 – 3.84	Optional
2	17 -20	3.84 – 6.49	Optional
3	26 – 30	6.49 – 12.95	Optional
4	36 – 44	12.95 - 25	Optional

A.3 DATA OUT PoE Injector RJ45 Port Pin Assignments

PIN NO	10BASE-T 100BASE-TX		1000BASE-T	
	1	TX+	DC-	DA+
2	TX-	DC-	DA-	DC-
3	RX+	DC+	DB+	DC+
4	-	DC+	DC+	DC+
5	-	DC+	DC-	DC+
6	RX-	DC+	DB-	DC+
7	-	DC-	DD+	DC-
8	-	DC0	DD-	DC0

A.4 RJ45 Pin Assignment of Non-802.3af/802.3at Standard PD with PoE Mid-span PD

Pin out of Cisco non-802.3af standard Pin out of POE Mid-span
PD

PIN NO	SIGNAL
1	RX+
2	RX-
3	TX+
4	VCC-
5	VCC-
6	TX-
7	VCC+
8	VCC+

PIN NO	SIGNAL
1	RX+
2	RX-
3	TX+
4	VCC-
5	VCC-
6	TX-
7	VCC+
8	VCC+

Before you power PD, please check whether the RJ45 connector pin assignment follows IEEE 802.3af/IEEE 802.3at standard; otherwise, you may need to change one of the RJ45 connector pin assignments, which is attached with the UTP cable.

APPENDIX B.

B.1 Recommended Use of the Connected Wires

The wire gauges for the current are shown below:

(Applicable to the system with voltage attenuation less than 3%)

Gauge	Diameter	Amp
AWG #16	1.295	10.00
AWG #17	1.143	8.40
AWG #18	1.016	6.40
AWG #19	0.914	5.20
AWG #20	0.813	4.00

B.2 Recommended Settings for Different Batteries

We suggest Nickel-cadmium battery and Lead-acid battery for BSP-360. You could set the Battery type at Battery Management on the web.

Use **Lead-acid** battery for BSP-360. You could set the Battery type at **Battery Management** on the web of BSP-360.

Battery Management

Battery Type	Lead-acid Battery ▾		
Battery Capacity	0	Ah	
Install Time of Battery	2022	1	12 Today
Battery Life	365	Days	
Fully-Charged Hold Time	60	Minute(s) (0~255) ⓘ	
Float Charge Voltage	27.2	V (26.0~30.0V)	
Absorption Charge Voltage	29.2	V (28.0~32.0V)	
Low Voltage Disconnection	22.2	V (21.0~23.0V)	
Low Voltage Reconnection	23.5	V (23.5~27.0V)	
Low Voltage Cut-off Protection Mode	OFF ▾		

Use **Lithium** battery for BSP-360. You could set the Battery type at **Battery Management** on the web of BSP-360.

Battery Management

Battery Type	Lithium Battery ▾		
Battery Capacity	0	Ah	
Install Time of Battery	2022	1	12 Today
Battery Life	365	Days	
Fully-Charged Hold Time	60	Minute(s) (0~255) ⓘ	
Low Voltage Disconnection	21.3	V (19.6~23.0V)	
Low Voltage Reconnection	24	V (23.5~25.0V)	
Low Voltage Cut-off Protection Mode	OFF ▾		

B.3 BSP-360 Battery Default Setting

Battery Information			
Setting	Type	Lithium Battery (Default)	Lead-acid Battery
	FCV (Float Charge Voltage)		26.6V
ACV (Absorption Charge Voltage)		28.7V	29.2 V
LVD (Low Voltage Disconnection)		21.3V	22.2 V
LVR (Low Voltage Reconnection)		24.0V	23.5 V
Default Charge Board LVD		21.3 V	
Default Charge Board LVR		24.0 V	